

Excaltbur™ LOW-NOISE HIGH-SPEED PRECISION OPERATIONAL AMPLIFIER

FEATURES

- **Controlled Baseline**
 - One Assembly Site
 - One Test Site
 - One Fabrication Site
- **Extended Temperature Performance of –55°C to 125°C**
- **Enhanced Diminishing Manufacturing Sources (DMS) Support**
- **Enhanced Product-Change Notification**
- **Qualification Pedigree⁽¹⁾**

⁽¹⁾ Component qualification in accordance with JEDEC and industry standards to ensure reliable operation over an extended temperature range. This includes, but is not limited to, Highly Accelerated Stress Test (HAST) or biased 85/85, temperature cycle, autoclave or unbiased HAST, electromigration, bond intermetallic life, and mold compound life. Such qualification testing should not be viewed as justifying use of this component beyond specified performance and environmental limits.
- **Low Noise**
 - 10 Hz...15 nV/√Hz
 - 1 kHz...10.5 nV/√Hz
- **10 000-pF Load Capability**
- **20-mA (Min) Short-Circuit Output Current**
- **27-V/μs Slew Rate (Min)**
- **High Gain-Bandwidth Product...5.9 MHz**
- **Low V_{IO}...900 μV (Max) at 25°C**
- **Single or Split Supply...4 V to 44 V**
- **Fast Settling Time**
 - 340 ns to 0.1%
 - 400 ns to 0.01%
- **Saturation Recovery...150 ns**
- **Large Output Swing...
V_{CC-} + 0.1 V to V_{CC+} – 1 V**

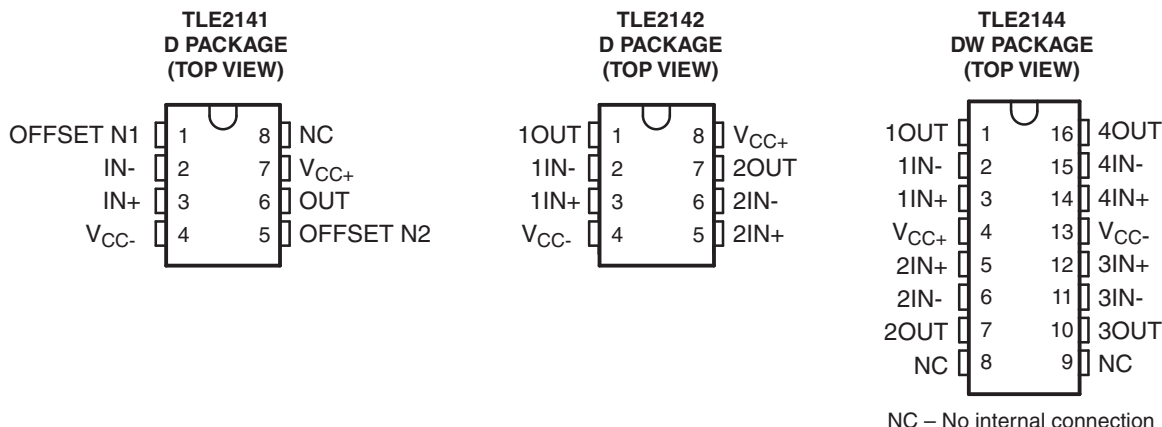

DESCRIPTION

The TLE214x devices are high-performance, internally compensated operational amplifiers built using the Texas Instruments complementary bipolar Excaltbur™ process. They are pin-compatible upgrades to standard industry products.

The design incorporates an input stage that simultaneously achieves low audio-band noise of 10.5 nV/√Hz with a 10-Hz 1/f corner and symmetrical 40-V/μs slew rate typically with loads up to 800 pF. The resulting low distortion and high power bandwidth are important in high-fidelity audio applications. A fast settling time of 340 ns to 0.1% of a 10-V step with a 2-kΩ/100-pF load is useful in fast actuator/positioning drivers. Under similar test conditions, settling time to 0.01% is 400 ns.



Please be aware that an important notice concerning availability, standard warranty, and use in critical applications of Texas Instruments semiconductor products and disclaimers thereto appears at the end of this data sheet.

Excaltbur is a trademark of Texas Instruments.

The devices are stable with capacitive loads up to 10 nF, although the 6-MHz bandwidth decreases to 1.8 MHz at this high loading level. As such, the TLE214x are useful for low-droop sample-and-holds and direct buffering of long cables, including 4-mA to 20-mA current loops.

The special design also exhibits an improved insensitivity to inherent integrated circuit component mismatches as is evidenced by a 900- μ V maximum offset voltage and 1.7- μ V/ $^{\circ}$ C typical drift. Minimum common-mode rejection ratio and supply-voltage rejection ratio are 85 dB and 90 dB, respectively.

Device performance is relatively independent of supply voltage over the ± 2 -V to ± 22 -V range. Inputs can operate between $V_{CC-} - 0.3$ V to $V_{CC+} - 1.8$ V without inducing phase reversal, although excessive input current may flow out of each input exceeding the lower common-mode input range. The all-npn output stage provides a nearly rail-to-rail output swing of $V_{CC-} - 0.1$ V to $V_{CC+} - 1$ V under light current-loading conditions. The device can sustain shorts to either supply since output current is internally limited, but care must be taken to ensure that maximum package power dissipation is not exceeded.

Both versions can also be used as comparators. Differential inputs of $V_{CC\pm}$ can be maintained without damage to the device. Open-loop propagation delay with TTL supply levels is typically 200 ns. This gives a good indication as to output stage saturation recovery when the device is driven beyond the limits of recommended output swing.

The TLE214x devices are available in industry-standard 8-pin and 16-pin small-outline packages. The devices are characterized for operation from -55° C to 125° C.

ORDERING INFORMATION⁽¹⁾

T_A	PACKAGE ⁽²⁾			ORDERABLE PART NUMBER	TOP-SIDE MARKING
-55° C to 125° C	Single	SOIC – D (8 pin)	Reel of 2500	TLE2141MDREP	2141EP
	Dual	SOIC – D (8 pin)	Reel of 2500	TLE2142MDREP ⁽³⁾	TBD
	Quad	SOIC – DW (16 pin)	Reel of 2000	TLE2144MDWREP ⁽³⁾	TBD

- (1) For the most current package and ordering information, see the Package Option Addendum at the end of this document, or see the TI web site at www.ti.com.
- (2) Package drawings, thermal data, and symbolization are available at www.ti.com/packaging.
- (3) Product Preview. Contact your TI sales representative for availability.

SYMBOL

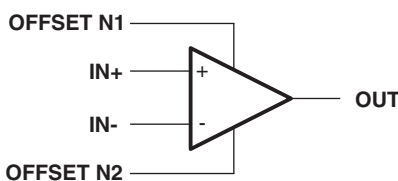

- A. OFFSET N1 and OFFSET N2 are available only on the TLE2141.

EQUIVALENT SCHEMATIC

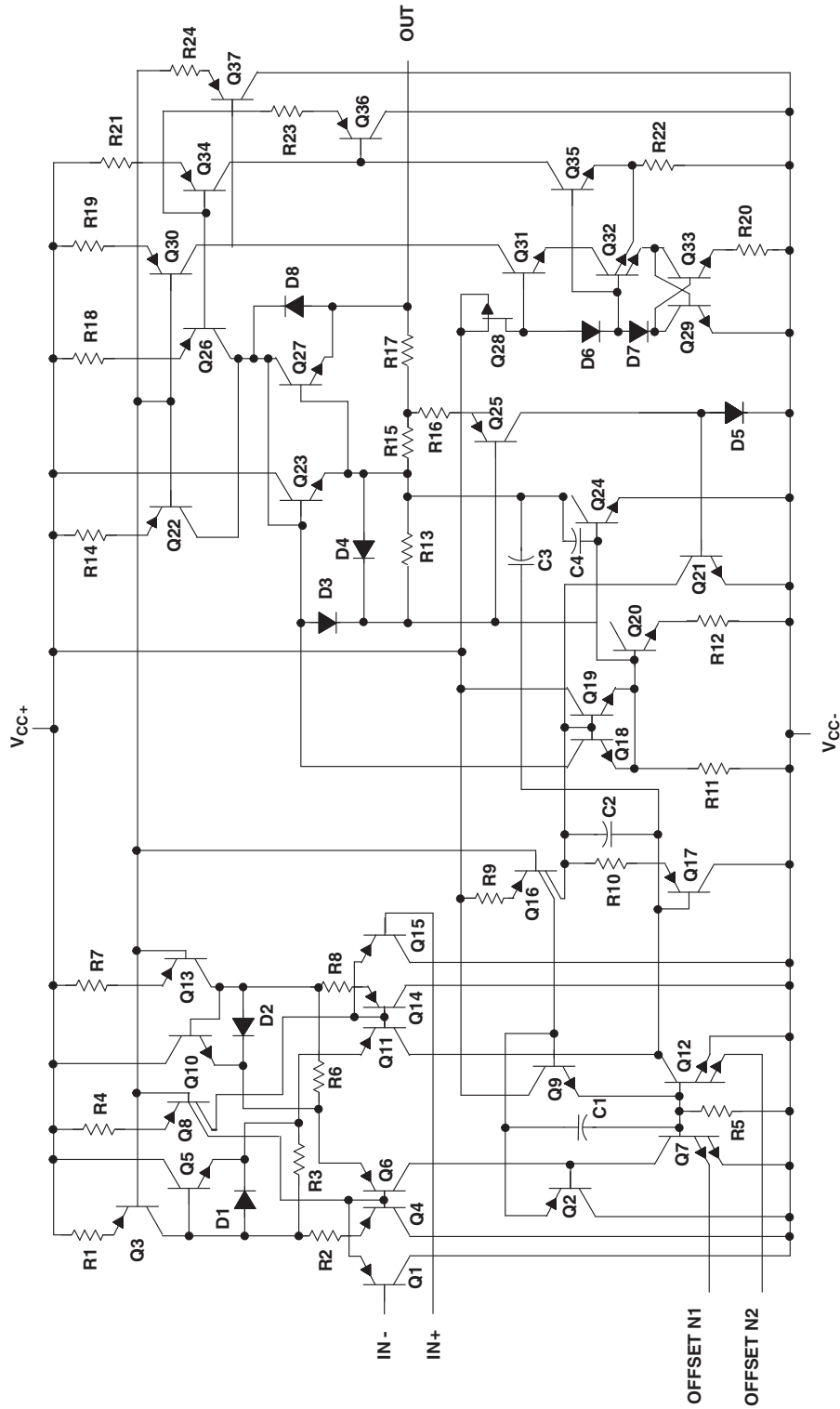

A. OFFSET N1 and OFFSET N2 are available only on the TLE2141.

DEVICE COMPONENT COUNT

COMPONENT	TLE2141	TLE2142	TLE2144
Transistors	46	65	130
Resistors	24	43	86
Diodes	8	14	28
Capacitors	4	8	16
Epi-FET	1	1	2

ABSOLUTE MAXIMUM RATINGS⁽¹⁾

over operating free-air temperature range (unless otherwise noted)

V_{CC+}	Supply voltage ⁽²⁾		22 V
V_{CC-}	Supply voltage		-22 V
V_{ID}	Differential input voltage ⁽³⁾		±44 V
V_I	Input voltage range (any input)		V_{CC+} V to $(V_{CC-} - 0.3)$ V
I_I	Input current (each input)		±1 mA
I_O	Output current		±80 mA
	Total current into V_{CC+}		80 mA
	Total current out of V_{CC-}		80 mA
	Duration of short-circuit current at (or below) 25°C ⁽⁴⁾		Unlimited
θ_{JA}	Package thermal impedance ⁽⁵⁾⁽⁶⁾	D package	97.1°C/W
		DW package	57.3°C/W
T_A	Operating free-air temperature range		-55°C to 125 °C
T_{stg}	Storage temperature range ⁽⁷⁾		-65°C to 150 °C
	Lead temperature 1,6 mm (1/16 inch) from case for 10 seconds		260°C

- (1) Stresses beyond those listed under *absolute maximum ratings* may cause permanent damage to the device. These are stress ratings only, and functional operation of the device at these or any other conditions beyond those indicated under *recommended operating conditions* is not implied. Exposure to absolute-maximum-rated conditions for extended periods may affect device reliability.
- (2) All voltage values, except differential voltages, are with respect to the midpoint between V_{CC+} and V_{CC-} .
- (3) Differential voltages are at IN+ with respect to IN-. Excessive current flows, if input, are brought below $V_{CC-} - 0.3$ V.
- (4) The output may be shorted to either supply. Temperature and/or supply voltages must be limited to ensure that the maximum dissipation rating is not exceeded.
- (5) Maximum power dissipation is a function of $T_J(\max)$, θ_{JA} , and T_A . The maximum allowable power dissipation at any allowable ambient temperature is $P_D = (T_J(\max) - T_A)/\theta_{JA}$. Operating at the absolute maximum T_J of 150°C can affect reliability.
- (6) The package thermal impedance is calculated in accordance with JESD 51-7.
- (7) Long-term high temperature storage and/or extended use at maximum recommended operating conditions may result in a reduction of overall device life. See http://www.ti.com/ep_quality for additional information on enhanced product packaging.

RECOMMENDED OPERATING CONDITIONS

		MIN	MAX	UNIT	
$V_{CC\pm}$	Supply voltage	±2	±22	V	
V_{IC}	Common-mode input voltage	$V_{CC} = 5$ V	0	2.7	V
		$V_{CC\pm} = \pm 15$ V	-15	12.7	
T_A	Operating free-air temperature	-55	125	°C	

TLE2141 ELECTRICAL CHARACTERISTICS

 $V_{CC} = 5\text{ V}$, at specified free-air temperature (unless otherwise noted)

PARAMETER	TEST CONDITIONS	T_A ⁽¹⁾	TLE2141			UNIT		
			MIN	TYP	MAX			
V_{IO} Input offset voltage	$V_O = 2.5\text{ V}$, $R_S = 50\ \Omega$, $V_{IC} = 2.5\text{ V}$	25°C		225	1400	μV		
		Full range			2100			
α_{VIO} Temperature coefficient of input offset voltage	$V_O = 2.5\text{ V}$, $R_S = 50\ \Omega$, $V_{IC} = 2.5\text{ V}$	Full range		1.7		$\mu\text{V}/^\circ\text{C}$		
I_{IO} Input offset current	$V_O = 2.5\text{ V}$, $R_S = 50\ \Omega$, $V_{IC} = 2.5\text{ V}$	25°C		8	100	nA		
		Full range			250			
I_{IB} Input bias current	$V_O = 2.5\text{ V}$, $R_S = 50\ \Omega$, $V_{IC} = 2.5\text{ V}$	25°C		-0.8	-2	μA		
		Full range			-2.3			
V_{ICR} Common-mode input voltage range	$R_S = 50\ \Omega$	25°C	0 to 3	-0.3 to 3.2		V		
		Full range	0 to 2.7	-0.3 to 2.9				
V_{OH} High-level output voltage	$I_{OH} = -150\ \mu\text{A}$ $I_{OH} = -1.5\text{ mA}$ $I_{OH} = -15\text{ mA}$ $I_{OH} = -100\ \mu\text{A}$ $I_{OH} = -1\text{ mA}$ $I_{OH} = -10\text{ mA}$	25°C		3.9	4.1	V		
				3.8	4			
				3.2	3.7			
		Full range		3.75				
				3.65				
				3.25				
V_{OL} Low-level output voltage	$I_{OL} = 150\ \mu\text{A}$ $I_{OL} = 1.5\text{ mA}$ $I_{OL} = 15\text{ mA}$ $I_{OL} = 100\ \mu\text{A}$ $I_{OL} = 1\text{ mA}$ $I_{OL} = 10\text{ mA}$	25°C			75	125	mV	
					150	225		
					1.2	1.6		
		Full range				200		mV
						250		
						1.25		
A_{VD} Large-signal differential voltage amplification	$V_{IC} = 2.5\text{ V}$, $R_L = 2\text{ k}\Omega$, $V_O = 1\text{ V}$ to -1.5 V	25°C	50	220		V/mV		
		Full range	5					
r_i Input resistance		25°C		70		M Ω		
c_i Input capacitance		25°C		2.5		pF		
z_o Open-loop output impedance	$f = 1\text{ MHz}$	25°C		30		Ω		
CMRR Common-mode rejection ratio	$V_{IC} = V_{ICR}(\text{min})$, $R_S = 50\ \Omega$	25°C	85	118		dB		
		Full range	80					
k_{SVR} Supply-voltage rejection ratio ($\Delta V_{CC\pm}/\Delta V_{IO}$)	$V_{CC\pm} = \pm 2.5\text{ V}$ to $\pm 15\text{ V}$, $R_S = 50\ \Omega$	25°C	90	106		dB		
		Full range	85					
I_{CC} Supply current	$V_O = 2.5\text{ V}$, No load, $V_{IC} = 2.5\text{ V}$	25°C		3.4	4.4	mA		
		Full range			4.6			

 (1) Full range is -55°C to 125°C .

TLE2141 OPERATING CHARACTERISTICS

$V_{CC} = 5\text{ V}$, $T_A = 25^\circ\text{C}$ (unless otherwise noted)

PARAMETER		TEST CONDITIONS		TLE2141			UNIT
				MIN	TYP	MAX	
SR+	Positive slew rate	$A_{VD} = -1$, $R_L = 2\text{ k}\Omega^{(1)}$, $C_L = 500\text{ pF}$			45		V/ μs
SR-	Negative slew rate	$A_{VD} = -1$, $R_L = 2\text{ k}\Omega^{(1)}$, $C_L = 500\text{ pF}$			42		V/ μs
t_s	Settling time	$A_{VD} = -1$, 2.5-V step	To 0.1%		0.16		μs
			To 0.01%		0.22		
V_n	Equivalent input noise voltage	$R_S = 20\ \Omega$	f = 10 Hz		15		nV/ $\sqrt{\text{Hz}}$
			f = 1 kHz		10.5		
$V_{N(PP)}$	Peak-to-peak equivalent input noise voltage	f = 0.1 Hz to 1 Hz			0.48		μV
		f = 0.1 Hz to 10 Hz			0.51		
I_n	Equivalent input noise current	f = 10 Hz			1.92		$\text{pA}/\sqrt{\text{Hz}}$
		f = 1 kHz			0.5		
THD+N	Total harmonic distortion plus noise	$V_O = 1\text{ V to }3\text{ V}$, $R_L = 2\text{ k}\Omega^{(1)}$, $A_{VD} = 2$, f = 10 kHz			0.0052		%
B_1	Unity-gain bandwidth	$R_L = 2\text{ k}\Omega^{(1)}$, $C_L = 100\text{ pF}^{(1)}$			5.9		MHz
	Gain-bandwidth product	$R_L = 2\text{ k}\Omega^{(1)}$, $C_L = 100\text{ pF}^{(1)}$, f = 100 kHz			5.8		MHz
B_{OM}	Maximum output-swing bandwidth	$V_{O(PP)} = 2\text{ V}$, $R_L = 2\text{ k}\Omega^{(1)}$, $A_{VD} = 1$			660		kHz
ϕ_m	Phase margin at unity gain	$R_L = 2\text{ k}\Omega^{(1)}$, $C_L = 100\text{ pF}^{(1)}$			57		$^\circ$

(1) R_L and C_L terminated to 2.5 V.

TLE2141 ELECTRICAL CHARACTERISTICS

 $V_{CC} = \pm 15\text{ V}$, at specified free-air temperature (unless otherwise noted)

PARAMETER	TEST CONDITIONS	$T_A^{(1)}$	TLE2141			UNIT
			MIN	TYP	MAX	
V_{IO} Input offset voltage	$V_{IC} = 0, R_S = 50\ \Omega$	25°C		200	900	μV
		Full range			1700	
α_{VIO} Temperature coefficient of input offset voltage	$V_{IC} = 0, R_S = 50\ \Omega$	Full range		1.7		$\mu\text{V}/^\circ\text{C}$
I_{IO} Input offset current	$V_{IC} = 0, R_S = 50\ \Omega$	25°C		7	100	nA
		Full range			250	
I_{IB} Input bias current	$V_{IC} = 0, R_S = 50\ \Omega$	25°C		-0.7	-1.5	μA
		Full range			-1.8	
V_{ICR} Common-mode input voltage range	$R_S = 50\ \Omega$	25°C	-15 to 13	-15.3 to 13.2		V
		Full range	-15 to 12.7	-15.3 to 12.9		
V_{OM+} Maximum positive peak output voltage swing	$I_O = -150\ \mu\text{A}$ $I_O = -1.5\ \text{mA}$ $I_O = -15\ \text{mA}$ $I_O = -100\ \mu\text{A}$ $I_O = -1\ \text{mA}$ $I_O = -10\ \text{mA}$	25°C		13.8	14.1	V
				13.7	14	
				13.1	13.7	
		Full range		13.7		
				13.6		
				13.1		
V_{OM-} Maximum negative peak output voltage swing	$I_O = 150\ \mu\text{A}$ $I_O = 1.5\ \text{mA}$ $I_O = 15\ \text{mA}$ $I_O = 100\ \mu\text{A}$ $I_O = 1\ \text{mA}$ $I_O = 10\ \text{mA}$	25°C		-14.7	-14.9	V
				-14.5	-14.8	
				-13.4	-13.8	
		Full range		-14.6		
				-14.5		
				-13.4		
A_{VD} Large-signal differential voltage amplification	$V_O = \pm 10\ \text{V}, R_L = 2\ \text{k}\Omega$	25°C	100	450	V/mV	
		Full range	20			
r_i Input resistance		25°C		65	$\text{M}\Omega$	
c_i Input capacitance		25°C		2.5	pF	
z_o Open-loop output impedance	$f = 1\ \text{MHz}$	25°C		30	Ω	
CMRR Common-mode rejection ratio	$V_{IC} = V_{ICR}(\text{min}), R_S = 50\ \Omega$	25°C	85	108	dB	
		Full range	80			
k_{SVR} Supply-voltage rejection ratio ($\Delta V_{CC\pm}/\Delta V_{IO}$)	$V_{CC\pm} = \pm 2.5\ \text{V to } \pm 15\ \text{V}, R_S = 50\ \Omega$	25°C	90	106	dB	
		Full range	85			
I_{OS} Short-circuit output current	$V_O = 0$	25°C	$V_{ID} = 1\ \text{V}$	-25	-50	mA
			$V_{ID} = -1\ \text{V}$	20	31	
I_{CC} Supply current	$V_O = 0, \text{No load}, V_{IC} = 2.5\ \text{V}$	25°C		3.5	4.5	mA
		Full range			4.7	

 (1) Full range is -55°C to 125°C .

TLE2141 OPERATING CHARACTERISTICS

$V_{CC} = \pm 15\text{ V}$, $T_A = 25^\circ\text{C}$ (unless otherwise noted)

PARAMETER		TEST CONDITIONS		TLE2141			UNIT
				MIN	TYP	MAX	
SR+	Positive slew rate	$A_{VD} = -1$, $R_L = 2\text{ k}\Omega$, $C_L = 100\text{ pF}$		27	45		V/ μs
SR–	Negative slew rate	$A_{VD} = -1$, $R_L = 2\text{ k}\Omega$, $C_L = 100\text{ pF}$		27	42		V/ μs
t_s	Settling time	$A_{VD} = -1$, 10-V step	To 0.1%	0.34			μs
			To 0.01%	0.4			
V_n	Equivalent input noise voltage	$R_S = 20\ \Omega$	f = 10 Hz	15			nV/ $\sqrt{\text{Hz}}$
			f = 1 kHz	10.5			
$V_{N(PP)}$	Peak-to-peak equivalent input noise voltage	f = 0.1 Hz to 1 Hz		0.48			μV
		f = 0.1 Hz to 10 Hz		0.51			
I_n	Equivalent input noise current	f = 10 Hz		1.89			pA/ $\sqrt{\text{Hz}}$
		f = 1 kHz		0.47			
THD+N	Total harmonic distortion plus noise	$V_{O(PP)} = 20\text{ V}$, $R_L = 2\text{ k}\Omega$, $A_{VD} = 10$, f = 10 kHz		0.01			%
B_1	Unity-gain bandwidth	$R_L = 2\text{ k}\Omega$, $C_L = 100\text{ pF}$		6			MHz
	Gain-bandwidth product	$R_L = 2\text{ k}\Omega$, $C_L = 100\text{ pF}$, f = 100 kHz		5.9			MHz
B_{OM}	Maximum output-swing bandwidth	$V_{O(PP)} = 20\text{ V}$, $A_{VD} = 1$, $R_L = 2\text{ k}\Omega$, $C_L = 100\text{ pF}$		668			kHz
ϕ_m	Phase margin at unity gain	$R_L = 2\text{ k}\Omega$, $C_L = 100\text{ pF}$		58			$^\circ$

TLE2142 ELECTRICAL CHARACTERISTICS

 $V_{CC} = 5\text{ V}$, at specified free-air temperature (unless otherwise noted)

PARAMETER	TEST CONDITIONS	T_A ⁽¹⁾	TLE2142			UNIT
			MIN	TYP	MAX	
V_{IO} Input offset voltage	$V_O = 2.5\text{ V}$, $R_S = 50\ \Omega$, $V_{IC} = 2.5\text{ V}$	25°C		220	1900	μV
		Full range			2600	
α_{VIO} Temperature coefficient of input offset voltage	$V_O = 2.5\text{ V}$, $R_S = 50\ \Omega$, $V_{IC} = 2.5\text{ V}$	Full range		1.7		$\mu\text{V}/^\circ\text{C}$
I_{IO} Input offset current	$V_O = 2.5\text{ V}$, $R_S = 50\ \Omega$, $V_{IC} = 2.5\text{ V}$	25°C		8	100	nA
		Full range			200	
I_{IB} Input bias current	$V_O = 2.5\text{ V}$, $R_S = 50\ \Omega$, $V_{IC} = 2.5\text{ V}$	25°C		-0.8	-2	μA
		Full range			-2.3	
V_{ICR} Common-mode input voltage range	$R_S = 50\ \Omega$	25°C	0 to 3	-0.3 to 3.2		V
		Full range	0 to 2.7	-0.3 to 2.9		
V_{OH} High-level output voltage	$I_{OH} = -150\ \mu\text{A}$ $I_{OH} = -1.5\text{ mA}$ $I_{OH} = -15\text{ mA}$ $I_{OH} = -100\ \mu\text{A}$ $I_{OH} = -1\text{ mA}$ $I_{OH} = -10\text{ mA}$	25°C		3.9	4.1	V
				3.8	4	
				3.4	3.7	
		Full range		3.75		
				3.65		
				3.45		
V_{OL} Low-level output voltage	$I_{OL} = 150\ \mu\text{A}$ $I_{OL} = 1.5\text{ mA}$ $I_{OL} = 15\text{ mA}$ $I_{OL} = 100\ \mu\text{A}$ $I_{OL} = 1\text{ mA}$ $I_{OL} = 10\text{ mA}$	25°C		75	125	mV
				150	225	
				1.2	1.4	
		Full range		200		
				250		
				1.25		
A_{VD} Large-signal differential voltage amplification	$V_{IC} = 2.5\text{ V}$, $R_L = 2\text{ k}\Omega$, $V_O = 1\text{ V to }1.5\text{ V}$	25°C	50	220	V/mV	
		Full range	5			
r_i Input resistance		25°C		70	$\text{M}\Omega$	
c_i Input capacitance		25°C		2.5	pF	
z_o Open-loop output impedance	$f = 1\text{ MHz}$	25°C		30	Ω	
CMRR Common-mode rejection ratio	$V_{IC} = V_{ICR}(\text{min})$, $R_S = 50\ \Omega$	25°C	85	118	dB	
		Full range	80			
k_{SVR} Supply-voltage rejection ratio ($\Delta V_{CC\pm}/\Delta V_{IO}$)	$V_{CC\pm} = \pm 2.5\text{ V to } \pm 15\text{ V}$, $R_S = 50\ \Omega$	25°C	90	106	dB	
		Full range	85			
I_{CC} Supply current	$V_O = 2.5\text{ V}$, No load, $V_{IC} = 2.5\text{ V}$	25°C		6.6	8.8	mA
		Full range			9.2	

 (1) Full range is -55°C to 125°C .

TLE2142 OPERATING CHARACTERISTICS

$V_{CC} = 5\text{ V}$, $T_A = 25^\circ\text{C}$ (unless otherwise noted)

PARAMETER		TEST CONDITIONS		TLE2142			UNIT
				MIN	TYP	MAX	
SR+	Positive slew rate	$A_{VD} = -1$, $R_L = 2\text{ k}\Omega^{(1)}$, $C_L = 500\text{ pF}$			45		V/ μs
SR–	Negative slew rate	$A_{VD} = -1$, $R_L = 2\text{ k}\Omega^{(1)}$, $C_L = 500\text{ pF}$			42		V/ μs
t_s	Settling time	$A_{VD} = -1$, 2.5-V step	To 0.1%		0.16		μs
			To 0.01%		0.22		
V_n	Equivalent input noise voltage	$R_S = 20\ \Omega$	$f = 10\text{ Hz}$		15		nV/ $\sqrt{\text{Hz}}$
			$f = 1\text{ kHz}$		10.5		
$V_{N(PP)}$	Peak-to-peak equivalent input noise voltage	$f = 0.1\text{ Hz to }1\text{ Hz}$			0.48		μV
		$f = 0.1\text{ Hz to }10\text{ Hz}$			0.51		
I_n	Equivalent input noise current	$f = 10\text{ Hz}$			1.92		$\text{pA}/\sqrt{\text{Hz}}$
		$f = 1\text{ kHz}$			0.5		
THD+N	Total harmonic distortion plus noise	$V_O = 1\text{ V to }3\text{ V}$, $R_L = 2\text{ k}\Omega^{(1)}$, $A_{VD} = 2$, $f = 10\text{ kHz}$			0.0052		%
B_1	Unity-gain bandwidth	$R_L = 2\text{ k}\Omega^{(1)}$, $C_L = 100\text{ pF}$			5.9		MHz
	Gain-bandwidth product	$R_L = 2\text{ k}\Omega^{(1)}$, $C_L = 100\text{ pF}$, $f = 100\text{ kHz}$			5.8		MHz
B_{OM}	Maximum output-swing bandwidth	$V_{O(PP)} = 2\text{ V}$, $R_L = 2\text{ k}\Omega^{(1)}$, $A_{VD} = 1$, $C_L = 100\text{ pF}$			660		kHz
ϕ_m	Phase margin at unity gain	$R_L = 2\text{ k}\Omega^{(1)}$, $C_L = 100\text{ pF}$			57		$^\circ$

(1) R_L terminated at 2.5 V.

TLE2142 ELECTRICAL CHARACTERISTICS

 $V_{CC} = \pm 15\text{ V}$, at specified free-air temperature (unless otherwise noted)

PARAMETER	TEST CONDITIONS	$T_A^{(1)}$	TLE2142			UNIT
			MIN	TYP	MAX	
V_{IO} Input offset voltage	$V_{IC} = 0, R_S = 50\ \Omega$	25°C		290	1200	μV
		Full range			2000	
α_{VIO} Temperature coefficient of input offset voltage	$V_{IC} = 0, R_S = 50\ \Omega$	Full range		1.7		$\mu\text{V}/^\circ\text{C}$
I_{IO} Input offset current	$V_{IC} = 0, R_S = 50\ \Omega$	25°C		7	100	nA
		Full range			250	
I_{IB} Input bias current	$V_{IC} = 0, R_S = 50\ \Omega$	25°C		-0.7	-1.5	μA
		Full range			-1.8	
V_{ICR} Common-mode input voltage range	$R_S = 50\ \Omega$	25°C	-15 to 13	-15.3 to 13.2		V
		Full range	-15 to 12.7	-15.3 to 12.9		
V_{OM+} Maximum positive peak output voltage swing	$I_O = -150\ \mu\text{A}$ $I_O = -1.5\ \text{mA}$ $I_O = -15\ \text{mA}$ $I_O = -100\ \mu\text{A}$ $I_O = -1\ \text{mA}$ $I_O = -10\ \text{mA}$	25°C		13.8	14.1	V
				13.7	14	
				13.3	13.7	
		Full range		13.7		
				13.6		
				13.3		
V_{OM-} Maximum negative peak output voltage swing	$I_O = 150\ \mu\text{A}$ $I_O = 1.5\ \text{mA}$ $I_O = 15\ \text{mA}$ $I_O = 100\ \mu\text{A}$ $I_O = 1\ \text{mA}$ $I_O = 10\ \text{mA}$	25°C		-14.7	-14.9	V
				-14.5	-14.8	
				-13.4	-13.8	
		Full range		-14.6		
				-14.5		
				-13.4		
A_{VD} Large-signal differential voltage amplification	$V_O = \pm 10\ \text{V}, R_L = 2\ \text{k}\Omega$	25°C	100	450	V/mV	
		Full range	20			
r_i Input resistance		25°C		65	M Ω	
c_i Input capacitance		25°C		2.5	pF	
z_o Open-loop output impedance	$f = 1\ \text{MHz}$	25°C		30	Ω	
CMRR Common-mode rejection ratio	$V_{IC} = V_{ICR}(\text{min}), R_S = 50\ \Omega$	25°C	85	108	dB	
		Full range	80			
k_{SVR} Supply-voltage rejection ratio ($\Delta V_{CC\pm}/\Delta V_{IO}$)	$V_{CC\pm} = \pm 2.5\ \text{V to } \pm 15\ \text{V}, R_S = 50\ \Omega$	25°C	90	106	dB	
		Full range	85			
I_{OS} Short-circuit output current	$V_O = 0$	25°C	$V_{ID} = 1\ \text{V}$	-25	-50	mA
			$V_{ID} = -1\ \text{V}$	20	31	
I_{CC} Supply current	$V_O = 0, \text{No load}, V_{IC} = 2.5\ \text{V}$	25°C		6.9	9	mA
		Full range			9.4	

 (1) Full range is -55°C to 125°C .

TLE2142 OPERATING CHARACTERISTICS

$V_{CC} = \pm 15\text{ V}$, $T_A = 25^\circ\text{C}$ (unless otherwise noted)

PARAMETER		TEST CONDITIONS		TLE2142			UNIT
				MIN	TYP	MAX	
SR+	Positive slew rate	$A_{VD} = -1$, $R_L = 2\text{ k}\Omega$, $C_L = 100\text{ pF}$		27	45		V/ μs
SR-	Negative slew rate	$A_{VD} = -1$, $R_L = 2\text{ k}\Omega$, $C_L = 100\text{ pF}$		27	42		V/ μs
t_s	Settling time	$A_{VD} = -1$, 10-V step	To 0.1%	0.34			μs
			To 0.01%	0.4			
V_n	Equivalent input noise voltage	$R_S = 20\ \Omega$	$f = 10\text{ Hz}$	15			nV/ $\sqrt{\text{Hz}}$
			$f = 1\text{ kHz}$	10.5			
$V_{n(PP)}$	Peak-to-peak equivalent input noise voltage	$f = 0.1\text{ Hz to }1\text{ Hz}$		0.48			μV
		$f = 0.1\text{ Hz to }10\text{ Hz}$		0.51			
I_n	Equivalent input noise current	$f = 10\text{ Hz}$		1.89			$\text{pA}/\sqrt{\text{Hz}}$
		$f = 1\text{ kHz}$		0.47			
THD+N	Total harmonic distortion plus noise	$V_{O(PP)} = 20\text{ V}$, $R_L = 2\text{ k}\Omega$, $A_{VD} = 10$, $f = 10\text{ kHz}$		0.01			%
B_1	Unity-gain bandwidth	$R_L = 2\text{ k}\Omega$, $C_L = 100\text{ pF}$		6			MHz
	Gain-bandwidth product	$R_L = 2\text{ k}\Omega$, $C_L = 100\text{ pF}$, $f = 100\text{ kHz}$		5.9			MHz
B_{OM}	Maximum output-swing bandwidth	$V_{O(PP)} = 20\text{ V}$, $A_{VD} = 1$, $R_L = 2\text{ k}\Omega$, $A_{VD} = 1$, $C_L = 100\text{ pF}$		668			kHz
ϕ_m	Phase margin at unity gain	$R_L = 2\text{ k}\Omega$, $C_L = 100\text{ pF}$		58			$^\circ$

TLE2144 ELECTRICAL CHARACTERISTICS

 $V_{CC} = 5\text{ V}$, at specified free-air temperature (unless otherwise noted)

PARAMETER	TEST CONDITIONS	T_A ⁽¹⁾	TLE2144			UNIT		
			MIN	TYP	MAX			
V_{IO} Input offset voltage	$V_O = 2.5\text{ V}$, $R_S = 50\ \Omega$, $V_{IC} = 2.5\text{ V}$	25°C		0.5	3.8	mV		
		Full range			5.2			
α_{VIO} Temperature coefficient of input offset voltage	$V_O = 2.5\text{ V}$, $R_S = 50\ \Omega$, $V_{IC} = 2.5\text{ V}$	Full range		1.7		$\mu\text{V}/^\circ\text{C}$		
I_{IO} Input offset current	$V_O = 2.5\text{ V}$, $R_S = 50\ \Omega$, $V_{IC} = 2.5\text{ V}$	25°C		8	100	nA		
		Full range			250			
I_{IB} Input bias current	$V_O = 2.5\text{ V}$, $R_S = 50\ \Omega$, $V_{IC} = 2.5\text{ V}$	25°C		-0.8	-2	μA		
		Full range			-2.3			
V_{ICR} Common-mode input voltage range	$R_S = 50\ \Omega$	25°C	0 to 3	-0.3 to 3.2		V		
		Full range	0 to 2.7	-0.3 to 2.9				
V_{OH} High-level output voltage	$I_{OH} = -150\ \mu\text{A}$ $I_{OH} = -1.5\text{ mA}$ $I_{OH} = -15\text{ mA}$ $I_{OH} = -100\ \mu\text{A}$ $I_{OH} = -1\text{ mA}$ $I_{OH} = -10\text{ mA}$	25°C		3.9	4.1	V		
				3.8	4			
				3.4	3.7			
		Full range		3.75				
				3.65				
				3.45				
V_{OL} Low-level output voltage	$I_{OL} = 150\ \mu\text{A}$ $I_{OL} = 1.5\text{ mA}$ $I_{OL} = 15\text{ mA}$ $I_{OL} = 100\ \mu\text{A}$ $I_{OL} = 1\text{ mA}$ $I_{OL} = 10\text{ mA}$	25°C			75	125	mV	
					150	225	V	
					1.2	1.6	V	
		Full range				200		mV
						250		mV
						1.45		V
A_{VD} Large-signal differential voltage amplification	$V_{IC} = 2.5\text{ V}$, $R_L = 2\text{ k}\Omega$, $V_O = 1\text{ V}$ to -1.5 V	25°C	50	95		V/mV		
		Full range	5					
r_i Input resistance		25°C		70		M Ω		
c_i Input capacitance		25°C		2.5		pF		
z_o Open-loop output impedance	$f = 1\text{ MHz}$	25°C		3.		Ω		
CMRR Common-mode rejection ratio	$V_{IC} = V_{ICR}(\text{min})$, $R_S = 50\ \Omega$	25°C	85	118		dB		
		Full range	80					
k_{SVR} Supply-voltage rejection ratio ($\Delta V_{CC\pm}/\Delta V_{IO}$)	$V_{CC\pm} = \pm 2.5\text{ V}$ to $\pm 15\text{ V}$, $R_S = 50\ \Omega$	25°C	90	106		dB		
		Full range	85					
I_{CC} Supply current	$V_O = 2.5\text{ V}$, No load, $V_{IC} = 2.5\text{ V}$	25°C		13.2	17.6	mA		
		Full range			18.4			

 (1) Full range is -55°C to 125°C .

TLE2144 OPERATING CHARACTERISTICS

$V_{CC} = 5\text{ V}$, $T_A = 25^\circ\text{C}$ (unless otherwise noted)

PARAMETER		TEST CONDITIONS		TLE2144			UNIT
				MIN	TYP	MAX	
SR+	Positive slew rate	$A_{VD} = -1$, $R_L = 2\text{ k}\Omega^{(1)}$, $C_L = 500\text{ pF}$			45		V/ μs
SR-	Negative slew rate	$A_{VD} = -1$, $R_L = 2\text{ k}\Omega^{(1)}$, $C_L = 500\text{ pF}$			42		V/ μs
t_s	Settling time	$A_{VD} = -1$, 2.5-V step	To 0.1%		0.16		μs
			To 0.01%		0.22		
V_n	Equivalent input noise voltage	$R_S = 20\ \Omega$	$f = 10\text{ Hz}$		15		nV/ $\sqrt{\text{Hz}}$
			$f = 1\text{ kHz}$		10.5		
$V_{N(PP)}$	Peak-to-peak equivalent input noise voltage	$f = 0.1\text{ Hz to }1\text{ Hz}$			0.48		μV
		$f = 0.1\text{ Hz to }10\text{ Hz}$			0.51		
I_n	Equivalent input noise current	$f = 10\text{ Hz}$			1.92		$\text{pA}/\sqrt{\text{Hz}}$
		$f = 1\text{ kHz}$			0.5		
THD+N	Total harmonic distortion plus noise	$V_O = 1\text{ V to }3\text{ V}$, $R_L = 2\text{ k}\Omega^{(1)}$, $A_{VD} = 2$, $f = 10\text{ kHz}$			0.0052		%
B_1	Unity-gain bandwidth	$R_L = 2\text{ k}\Omega^{(1)}$, $C_L = 100\text{ pF}$			5.9		MHz
	Gain-bandwidth product	$R_L = 2\text{ k}\Omega^{(1)}$, $C_L = 100\text{ pF}$, $f = 100\text{ kHz}$			5.8		MHz
B_{OM}	Maximum output-swing bandwidth	$V_{O(PP)} = 2\text{ V}$, $R_L = 2\text{ k}\Omega^{(1)}$, $A_{VD} = 1$			660		kHz
ϕ_m	Phase margin at unity gain	$R_L = 2\text{ k}\Omega^{(1)}$, $C_L = 100\text{ pF}$			57		$^\circ$

(1) R_L terminated at 2.5 V.

TLE2144 ELECTRICAL CHARACTERISTICS

 $V_{CC} = \pm 15\text{ V}$, at specified free-air temperature (unless otherwise noted)

PARAMETER	TEST CONDITIONS	T_A ⁽¹⁾	TLE2144			UNIT
			MIN	TYP	MAX	
V_{IO} Input offset voltage	$V_{IC} = 0$, $R_S = 50\ \Omega$	25°C		0.6	2.4	mV
		Full range			4	
α_{VIO} Temperature coefficient of input offset voltage	$V_{IC} = 0$, $R_S = 50\ \Omega$	25°C		1.7		$\mu\text{V}/^\circ\text{C}$
I_{IO} Input offset current	$V_{IC} = 0$, $R_S = 50\ \Omega$	25°C		7	100	nA
		Full range			250	
I_{IB} Input bias current	$V_{IC} = 0$, $R_S = 50\ \Omega$	25°C		-0.7	-1.5	μA
		Full range			-1.8	
V_{ICR} Common-mode input voltage range	$R_S = 50\ \Omega$	25°C	-15 to 13	-15.3 to 13.2		V
		Full range	-15 to 12.7	-15.3 to 12.9		
V_{OM+} Maximum positive peak output voltage swing	$I_O = -150\ \mu\text{A}$	25°C		13.8	14.1	V
	$I_O = -1.5\ \text{mA}$			13.7	14	
	$I_O = -15\ \text{mA}$			13.1	13.7	
	Full range	$I_O = -100\ \mu\text{A}$		13.7		
		$I_O = -1\ \text{mA}$		13.6		
		$I_O = -10\ \text{mA}$		13.1		
V_{OM-} Maximum negative peak output voltage swing	$I_O = 150\ \mu\text{A}$	25°C		-14.7	-14.9	V
	$I_O = 1.5\ \text{mA}$			-14.5	-14.8	
	$I_O = 15\ \text{mA}$			-13.4	-13.8	
	Full range	$I_O = 100\ \mu\text{A}$		-14.6		
		$I_O = 1\ \text{mA}$		-14.5		
		$I_O = 10\ \text{mA}$		-13.4		
A_{VD} Large-signal differential voltage amplification	$V_O = \pm 10\ \text{V}$, $R_L = 2\ \text{k}\Omega$	25°C	100	170	V/mV	
		Full range	20			
r_i Input resistance		25°C		65	$\text{M}\Omega$	
c_i Input capacitance		25°C		2.5	pF	
z_o Open-loop output impedance	$f = 1\ \text{MHz}$	25°C		30	Ω	
CMRR Common-mode rejection ratio	$V_{IC} = V_{ICR}(\text{min})$, $R_S = 50\ \Omega$	25°C	85	108	dB	
		Full range	80			
k_{SVR} Supply-voltage rejection ratio ($\Delta V_{CC\pm}/\Delta V_{IO}$)	$V_{CC\pm} = \pm 2.5\ \text{V}$ to $\pm 15\ \text{V}$, $R_S = 50\ \Omega$	25°C	90	106	dB	
		Full range	85			
I_{OS} Short-circuit output current	$V_O = 0$	25°C	$V_{ID} = 1\ \text{V}$	-25	-50	mA
			$V_{ID} = -1\ \text{V}$	20	31	
I_{CC} Supply current	$V_O = 0$, No load, $V_{IC} = 2.5\ \text{V}$	25°C		13.8	18	mA
		Full range			18.8	

 (1) Full range is -55°C to 125°C .

TLE2144 OPERATING CHARACTERISTICS

$V_{CC} = \pm 15\text{ V}$, $T_A = 25^\circ\text{C}$ (unless otherwise noted)

PARAMETER		TEST CONDITIONS		TLE2144			UNIT
				MIN	TYP	MAX	
SR+	Positive slew rate	$A_{VD} = -1$, $R_L = 2\text{ k}\Omega$, $C_L = 100\text{ pF}$		27	45		V/ μs
SR-	Negative slew rate	$A_{VD} = -1$, $R_L = 2\text{ k}\Omega$, $C_L = 100\text{ pF}$		27	42		V/ μs
t_s	Settling time	$A_{VD} = -1$, 10-V step	To 0.1%	0.34			μs
			To 0.01%	0.4			
V_n	Equivalent input noise voltage	$R_S = 20\ \Omega$	$f = 10\text{ Hz}$	15			$\text{nV}/\sqrt{\text{Hz}}$
			$f = 1\text{ kHz}$	10.5			
$V_{n(PP)}$	Peak-to-peak equivalent input noise voltage	$f = 0.1\text{ Hz to }1\text{ Hz}$		0.48			μV
		$f = 0.1\text{ Hz to }10\text{ Hz}$		0.51			
I_n	Equivalent input noise current	$f = 10\text{ Hz}$		1.89			$\text{pA}/\sqrt{\text{Hz}}$
		$f = 10\text{ kHz}$		0.47			
THD+N	Total harmonic distortion plus noise	$V_{O(PP)} = 20\text{ V}$, $R_L = 2\text{ k}\Omega$, $A_{VD} = 10$, $f = 10\text{ kHz}$		0.01			%
B_1	Unity-gain bandwidth	$R_L = 2\text{ k}\Omega$, $C_L = 100\text{ pF}$		6			MHz
	Gain-bandwidth product	$R_L = 2\text{ k}\Omega$, $C_L = 100\text{ pF}$, $f = 100\text{ kHz}$		5.9			MHz
B_{OM}	Maximum output-swing bandwidth	$V_{O(PP)} = 20\text{ V}$, $A_{VD} = 1$, $R_L = 2\text{ k}\Omega$, $C_L = 100\text{ pF}$		668			kHz
ϕ_m	Phase margin at unity gain	$R_L = 2\text{ k}\Omega$, $C_L = 100\text{ pF}$		58			$^\circ$

TYPICAL CHARACTERISTICS

Table of Graphs

V_{IO}	Input offset voltage	Distribution	Figure 1, Figure 2, Figure 3
I_{IO}	Input offset current	vs Free-air temperature	Figure 4
I_{IB}	Input bias current	vs Common-mode input voltage	Figure 5
		vs Free-air temperature	Figure 6
V_{OM+}	Maximum positive peak output voltage	vs Supply voltage	Figure 7
		vs Free-air temperature	Figure 8
		vs Output current	Figure 9
		vs Settling time	Figure 11
V_{OM-}	Maximum negative peak output voltage	vs Supply voltage	Figure 7
		vs Free-air temperature	Figure 8
		vs Output current	Figure 10
		vs Settling time	Figure 11
$V_{O(PP)}$	Maximum peak-to-peak output voltage	vs Frequency	Figure 12
V_{OH}	High-level output voltage	vs Output current	Figure 13
V_{OL}	Low-level output voltage	vs Output current	Figure 14
	Phase shift	vs Frequency	Figure 15
A_{VD}	Large-signal differential voltage amplification	vs Frequency	Figure 15
		vs Free-air temperature	Figure 16
z_o	Closed-loop output impedance	vs Frequency	Figure 17
I_{OS}	Short-circuit output current	vs Free-air temperature	Figure 18
CMRR	Common-mode rejection ratio	vs Frequency	Figure 19
		vs Free-air temperature	Figure 20
k_{SVR}	Supply-voltage rejection ratio	vs Frequency	Figure 21
		vs Free-air temperature	Figure 22
I_{CC}	Supply current	vs Supply voltage	Figure 23
		vs Free-air temperature	Figure 24
V_n	Equivalent input noise voltage	vs Frequency	Figure 25
V_n	Input noise voltage	Over a 10-second period	Figure 26
I_n	Noise current	vs Frequency	Figure 27
THD+N	Total harmonic distortion plus noise	vs Frequency	Figure 28
SR	Slew rate	vs Free-air temperature	Figure 29
		vs Load capacitance	Figure 30
Pulse response	Noninverting large signal	vs Time	Figure 31
	Inverting large signal	vs Time	Figure 32
	Small signal	vs Time	Figure 33
B_1	Unity-gain bandwidth	vs Load capacitance	Figure 34
	Gain margin	vs Load capacitance	Figure 35
ϕ_m	Phase margin	vs Load capacitance	Figure 36

TLE2141
 DISTRIBUTION OF
 INPUT OFFSET VOLTAGE

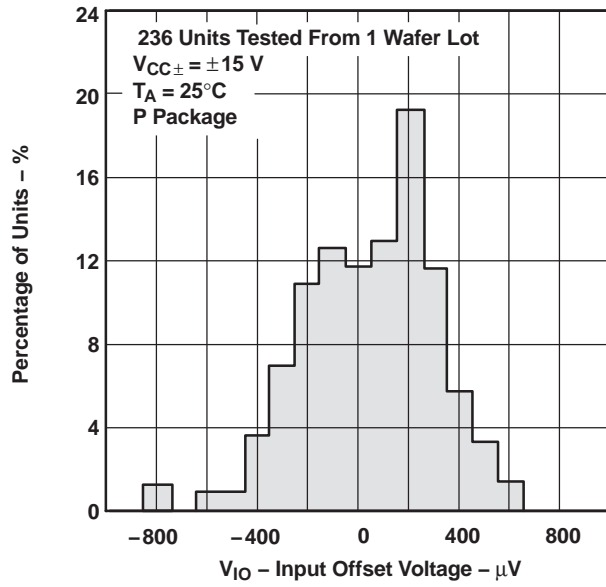

Figure 1.

TLE2142
 DISTRIBUTION OF
 INPUT OFFSET VOLTAGE

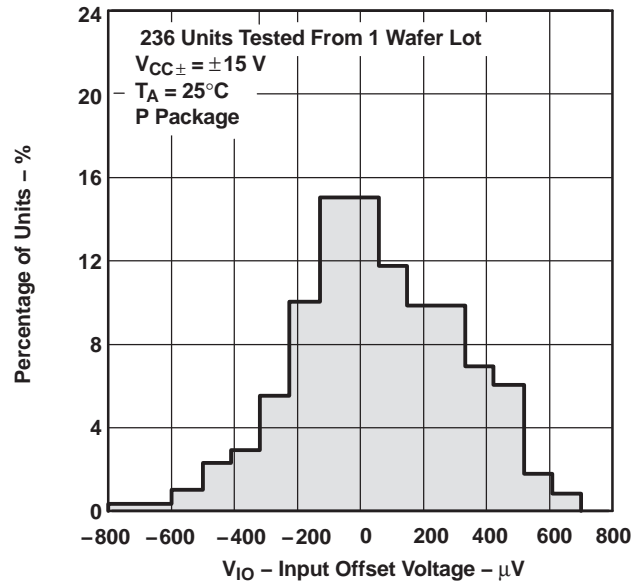

Figure 2.

TLE2144
 DISTRIBUTION OF
 INPUT OFFSET VOLTAGE

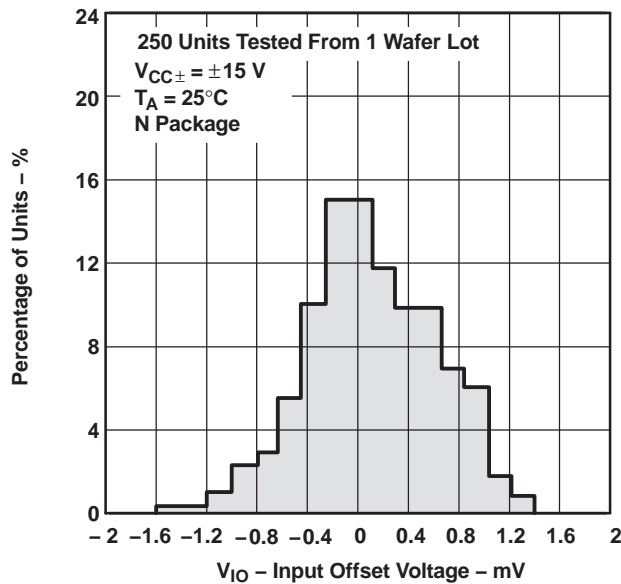

Figure 3.

INPUT OFFSET CURRENT
 vs
 FREE-AIR TEMPERATURE

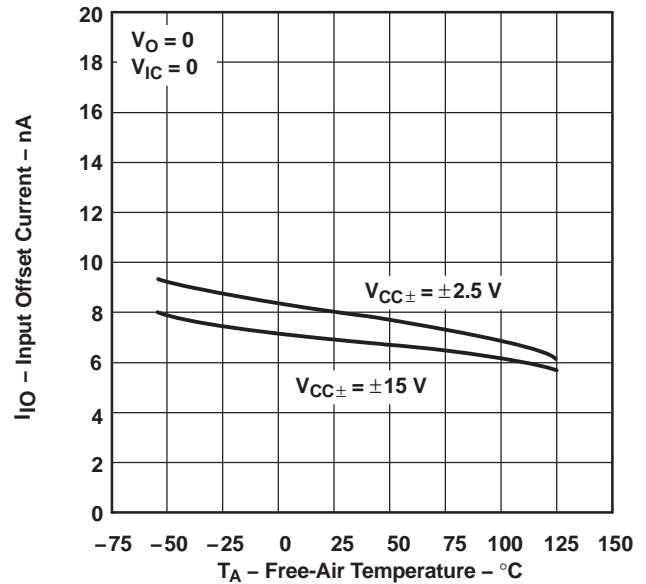

Figure 4.

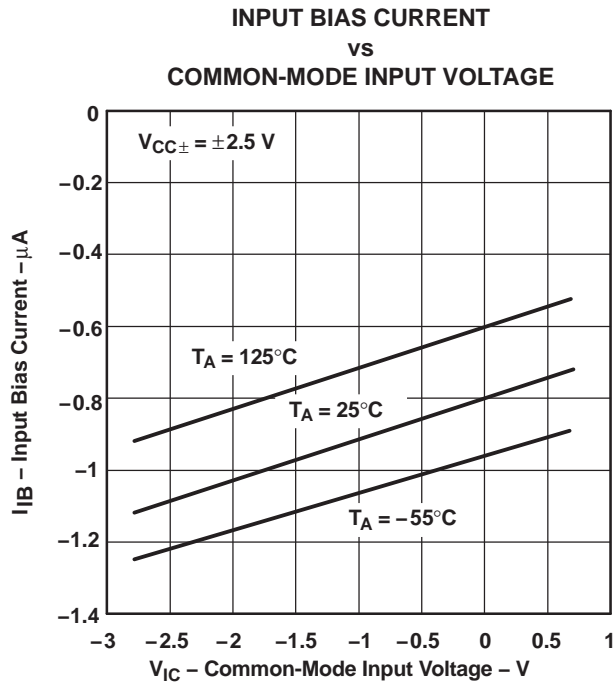

Figure 5.

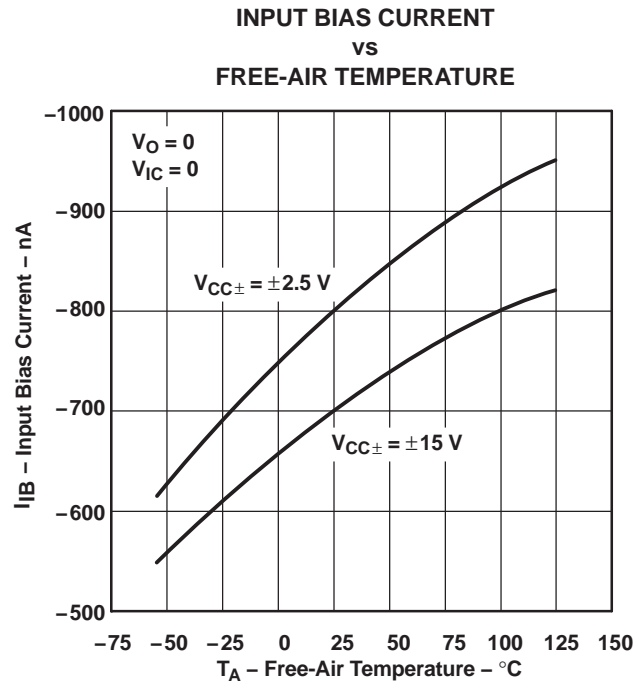

Figure 6.

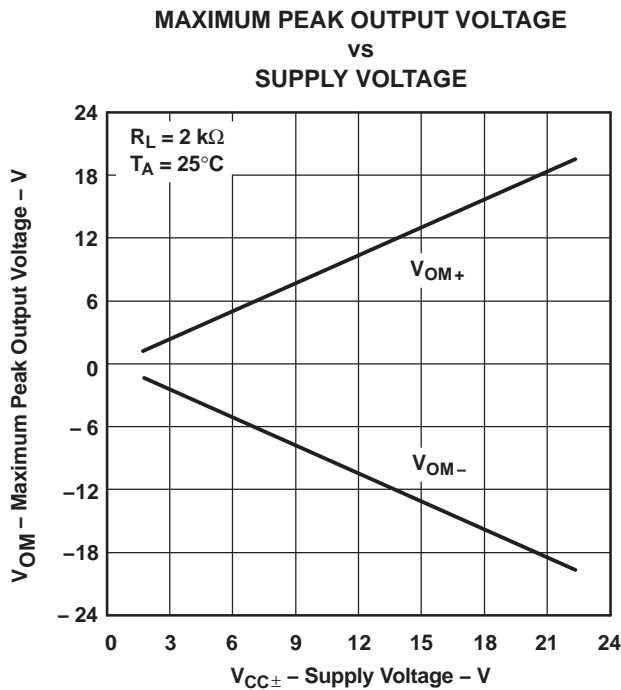

Figure 7.

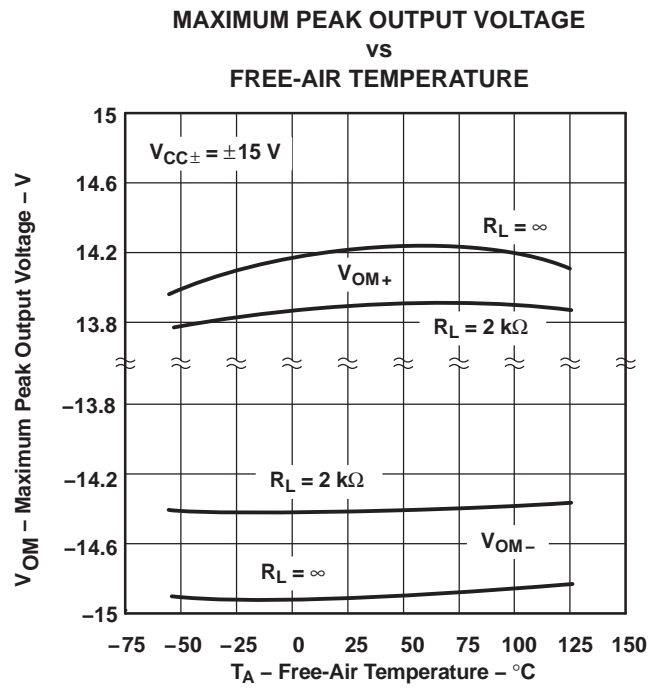

Figure 8.

MAXIMUM POSITIVE PEAK
OUTPUT VOLTAGE
vs
OUTPUT CURRENT

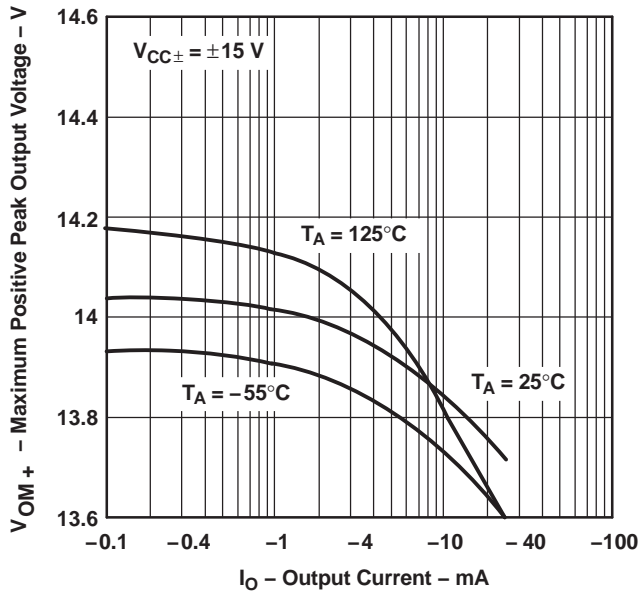

Figure 9.

MAXIMUM NEGATIVE PEAK
OUTPUT VOLTAGE
vs
OUTPUT CURRENT

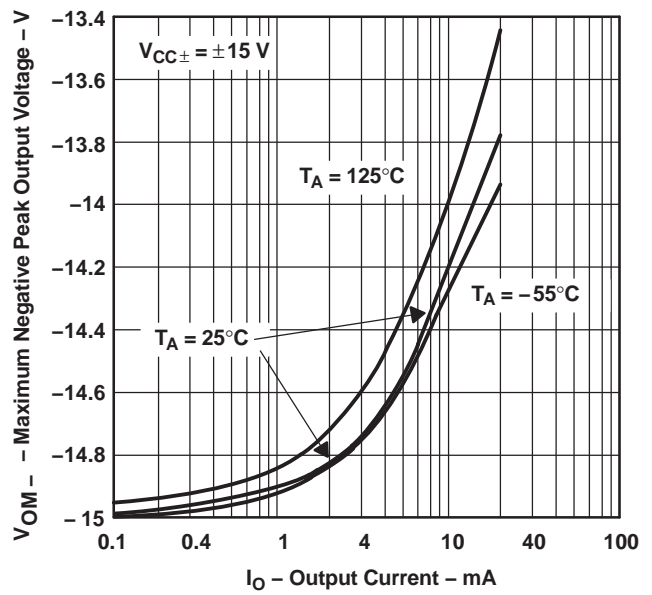

Figure 10.

MAXIMUM PEAK OUTPUT VOLTAGE
vs
SETTLING TIME

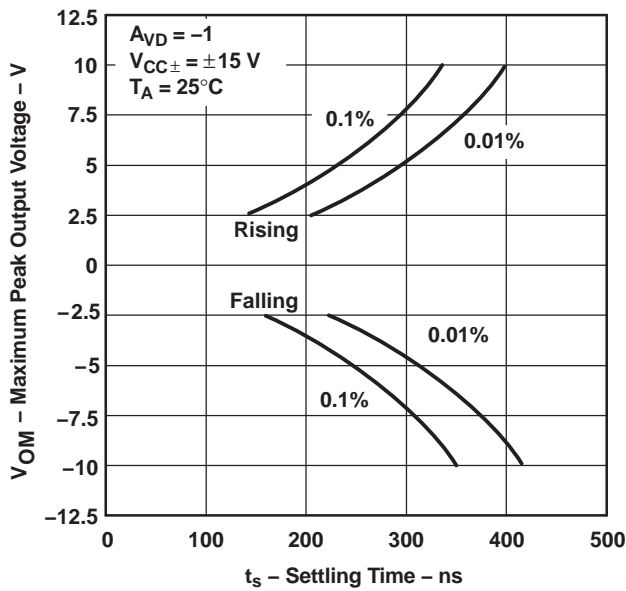

Figure 11.

MAXIMUM PEAK-TO-PEAK
OUTPUT VOLTAGE
vs
FREQUENCY

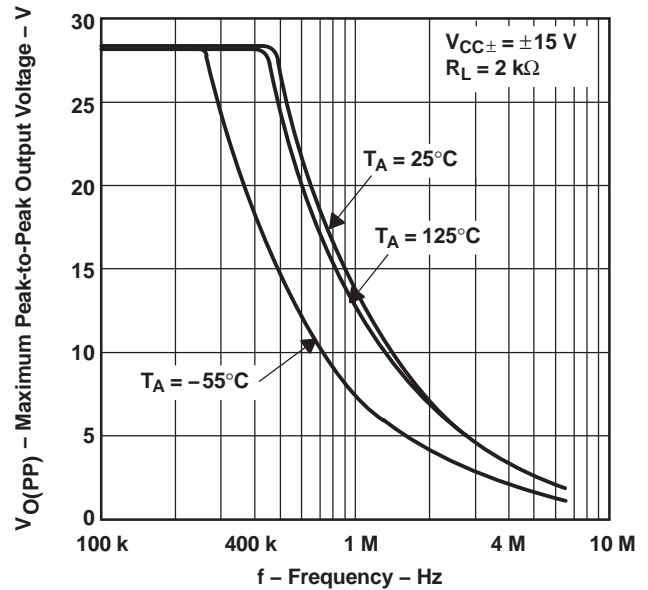

Figure 12.

HIGH-LEVEL OUTPUT VOLTAGE
VS
OUTPUT CURRENT

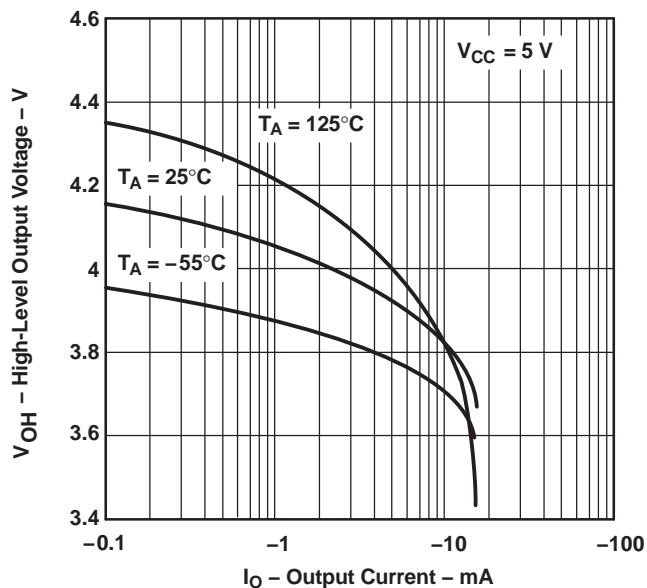

Figure 13.

LOW-LEVEL OUTPUT VOLTAGE
VS
OUTPUT CURRENT

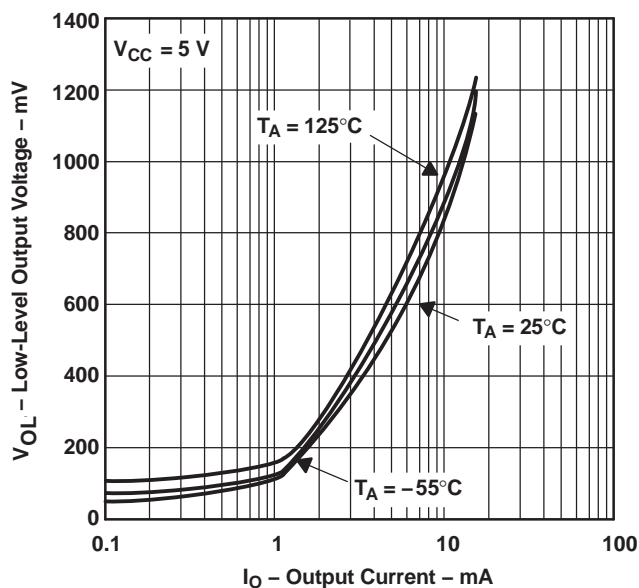

Figure 14.

LARGE-SIGNAL DIFFERENTIAL VOLTAGE
AMPLIFICATION AND PHASE SHIFT
VS
FREQUENCY

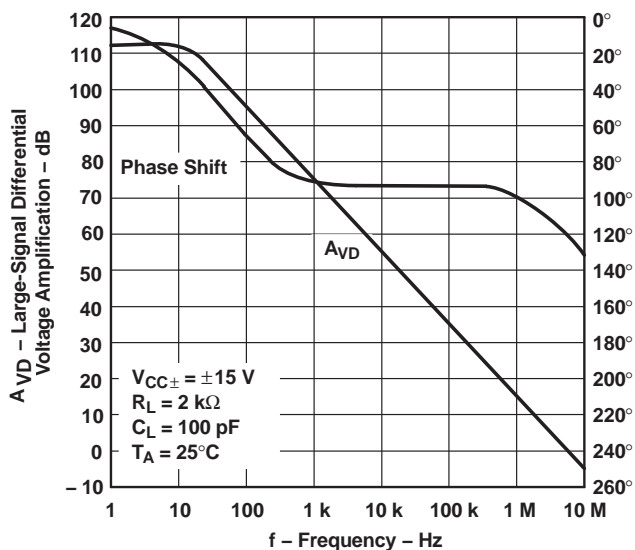

Figure 15.

LARGE-SIGNAL DIFFERENTIAL
VOLTAGE AMPLIFICATION
VS
FREE-AIR TEMPERATURE

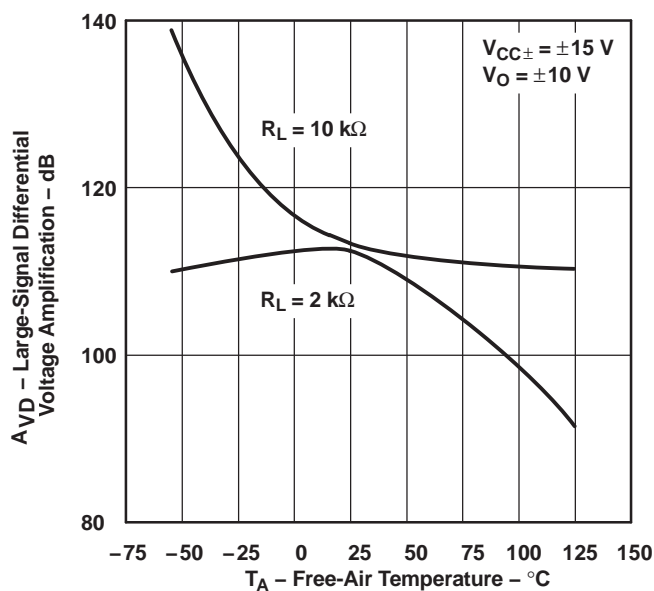

Figure 16.

CLOSED-LOOP OUTPUT IMPEDANCE
 VS
 FREQUENCY

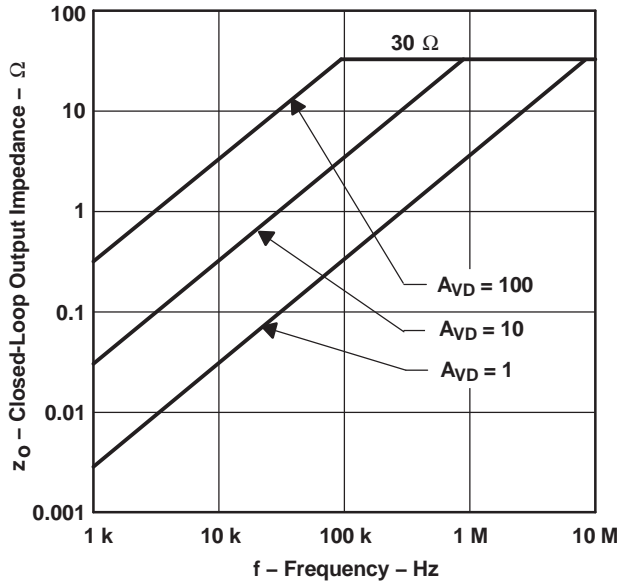

Figure 17.

SHORT-CIRCUIT OUTPUT CURRENT
 VS
 FREE-AIR TEMPERATURE

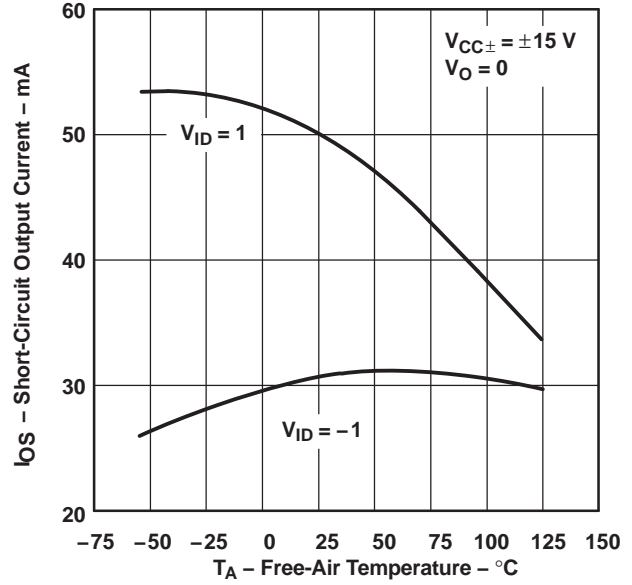

Figure 18.

COMMON-MODE REJECTION RATIO
 VS
 FREQUENCY

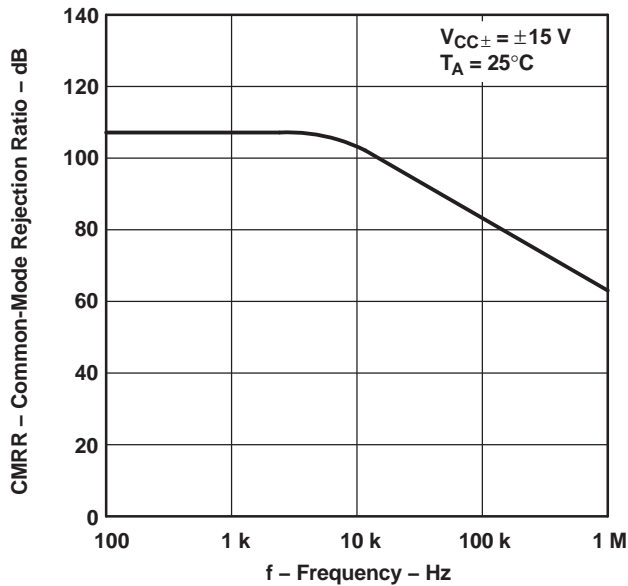

Figure 19.

COMMON-MODE REJECTION RATIO
 VS
 FREE-AIR TEMPERATURE

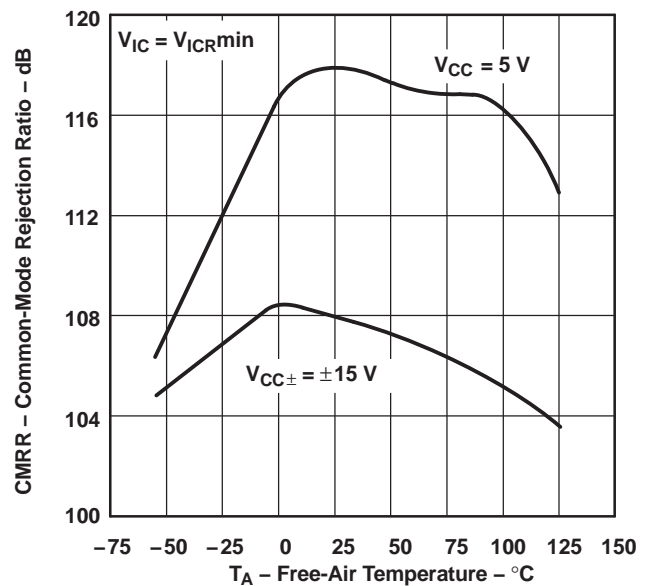

Figure 20.

SUPPLY-VOLTAGE REJECTION RATIO
VS
FREQUENCY

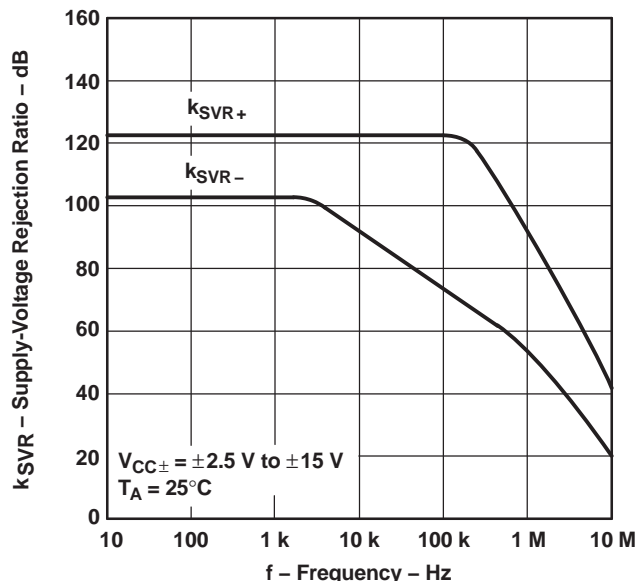

Figure 21.

SUPPLY-VOLTAGE REJECTION RATIO
VS
FREE-AIR TEMPERATURE

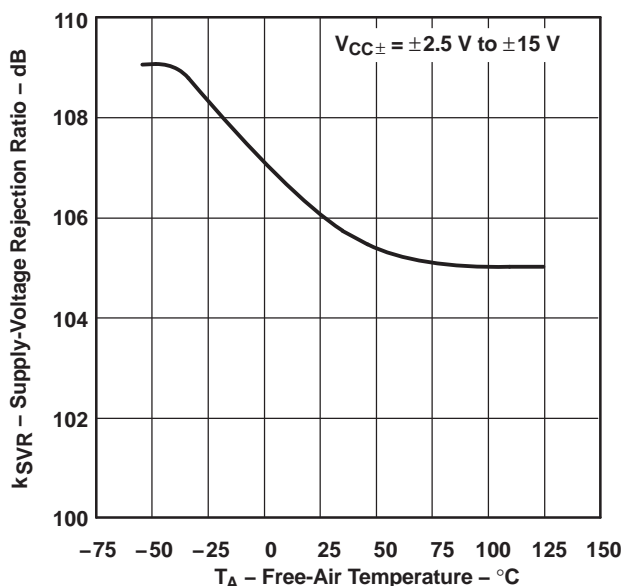

Figure 22.

SUPPLY CURRENT
VS
SUPPLY VOLTAGE

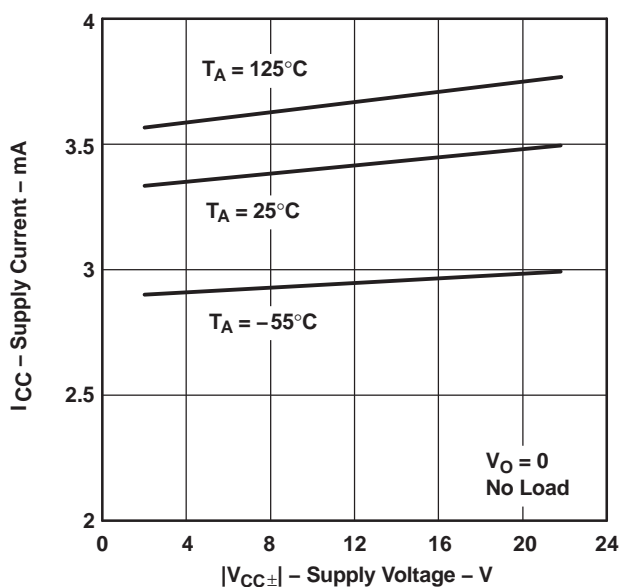

Figure 23.

SUPPLY CURRENT
VS
FREE-AIR TEMPERATURE

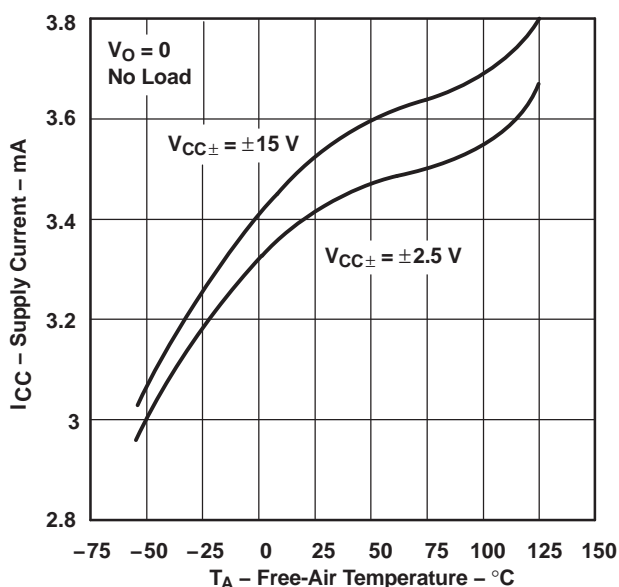

Figure 24.

EQUIVALENT INPUT NOISE VOLTAGE
vs
FREQUENCY

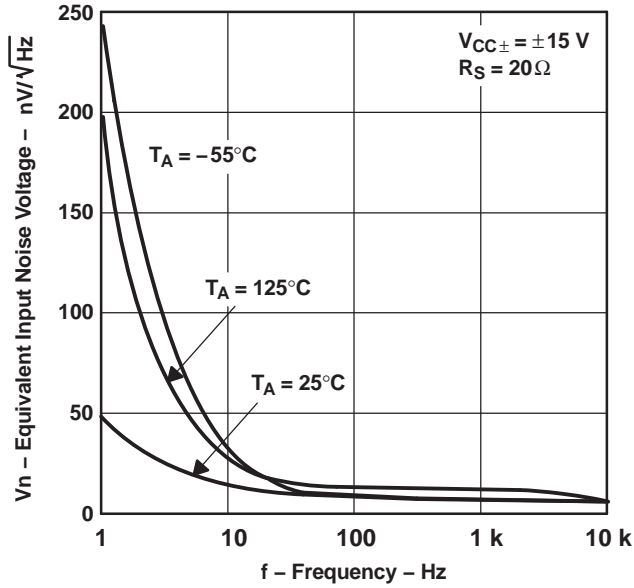

Figure 25.
NOISE CURRENT
vs
FREQUENCY

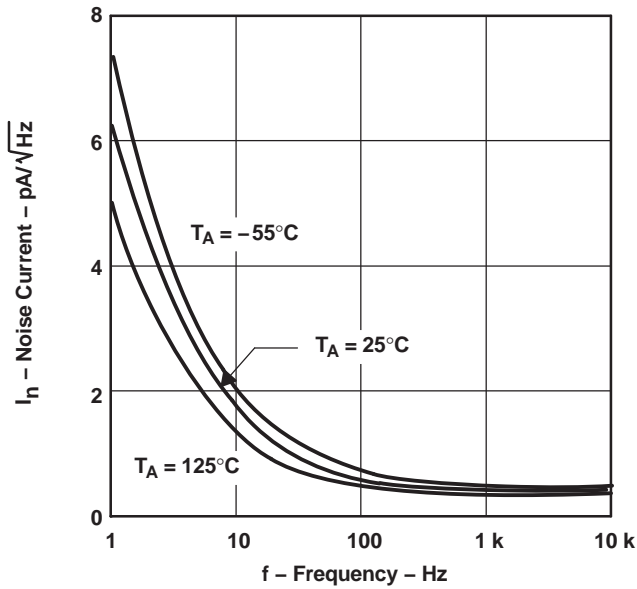

Figure 27.

INPUT NOISE VOLTAGE
OVER A 10-SECOND PERIOD

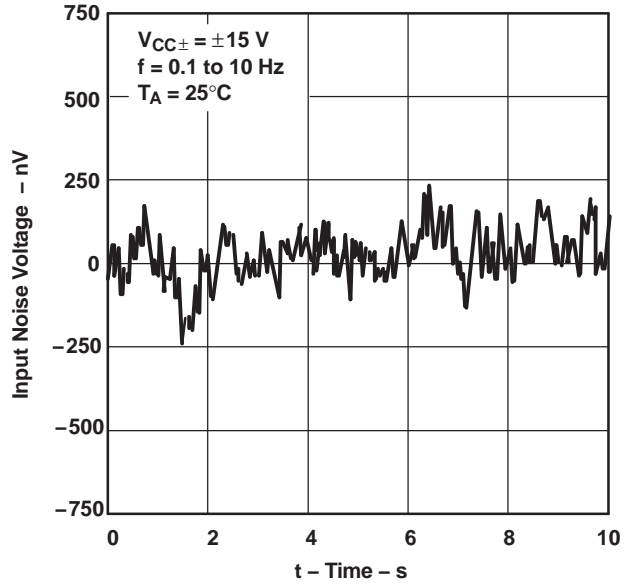

Figure 26.

TOTAL HARMONIC DISTORTION
PLUS NOISE
vs
FREQUENCY

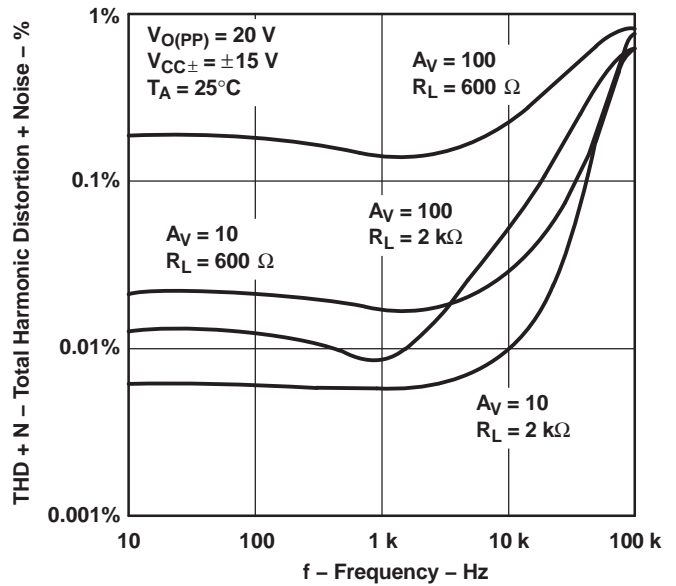
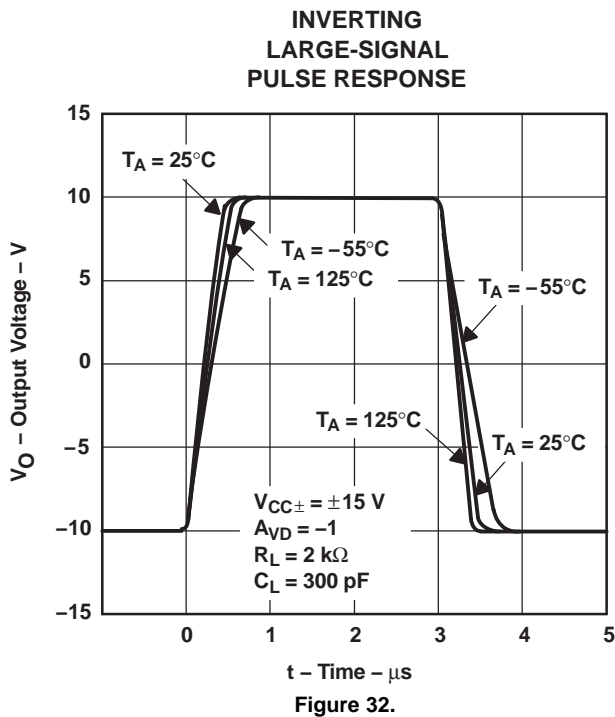
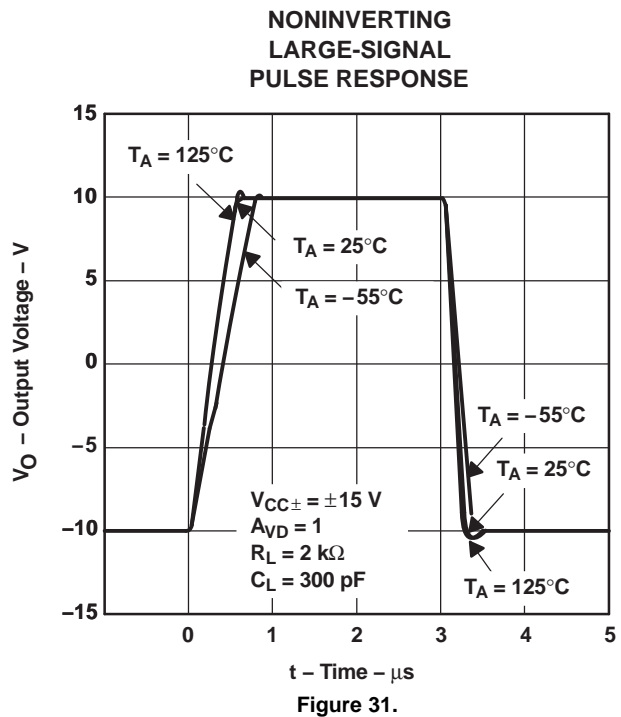
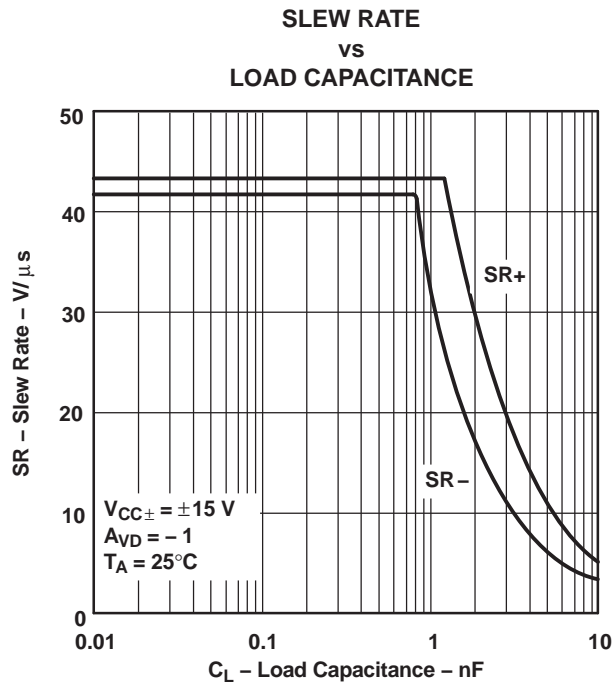
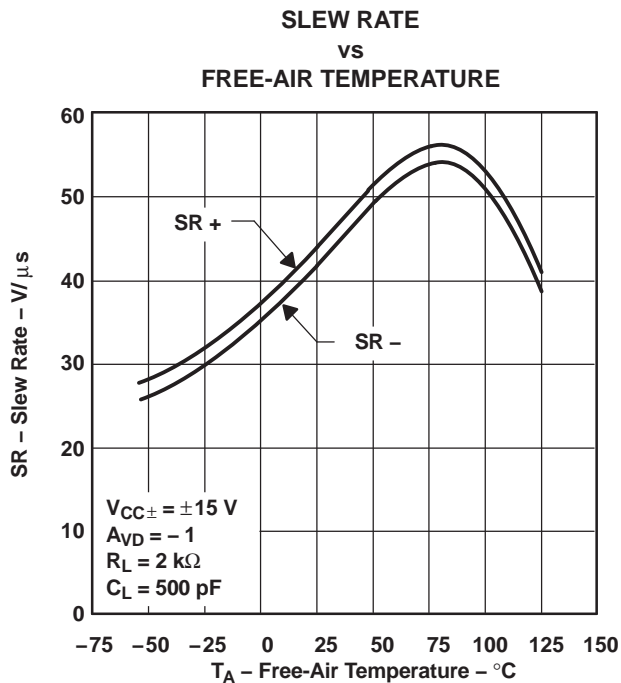

Figure 28.



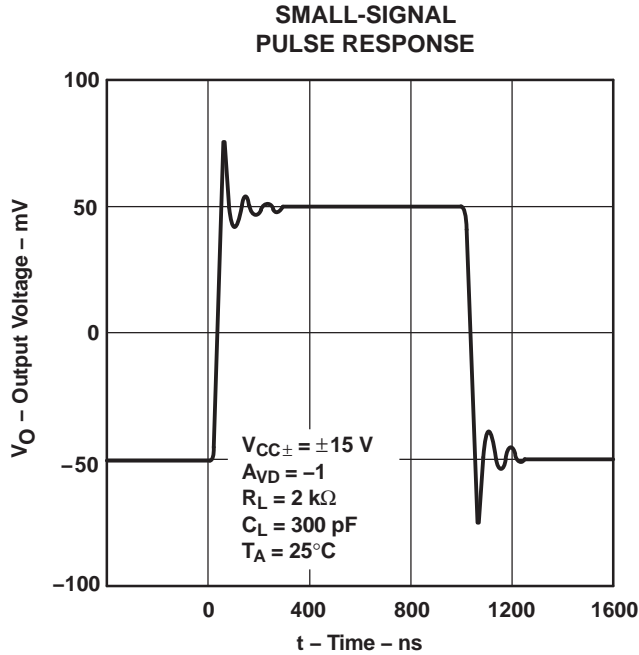

Figure 33.

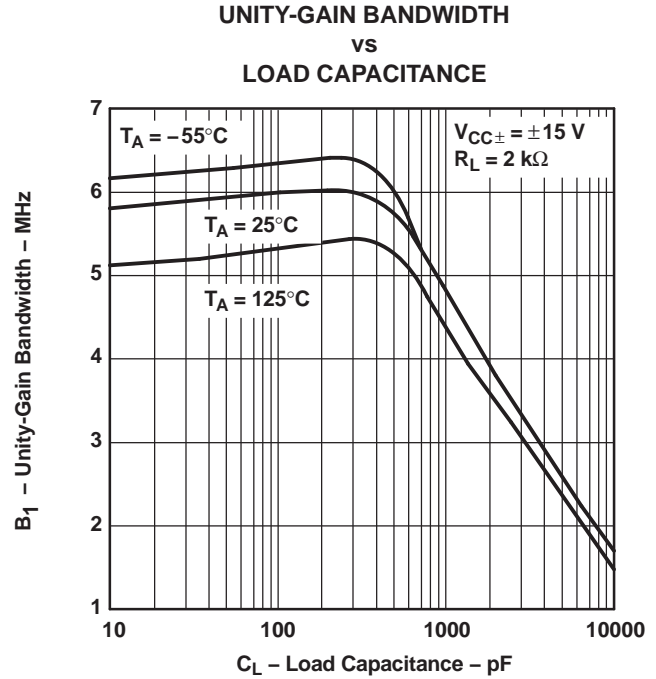

Figure 34.

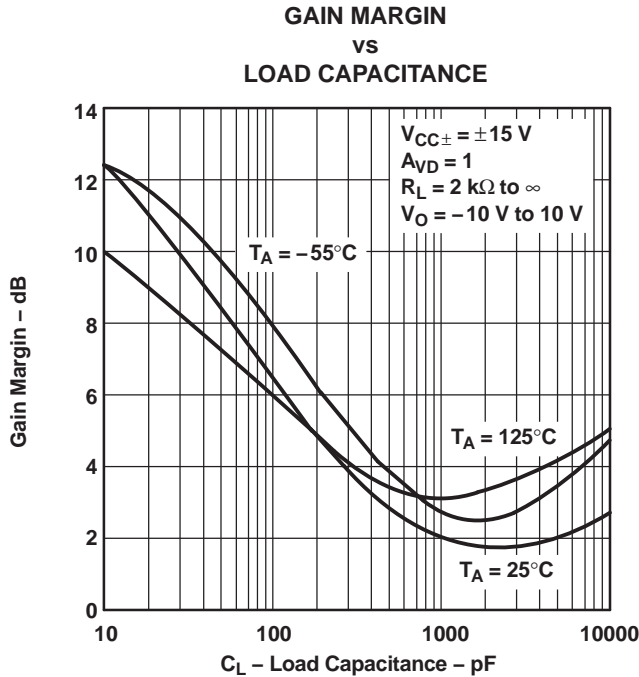

Figure 35.

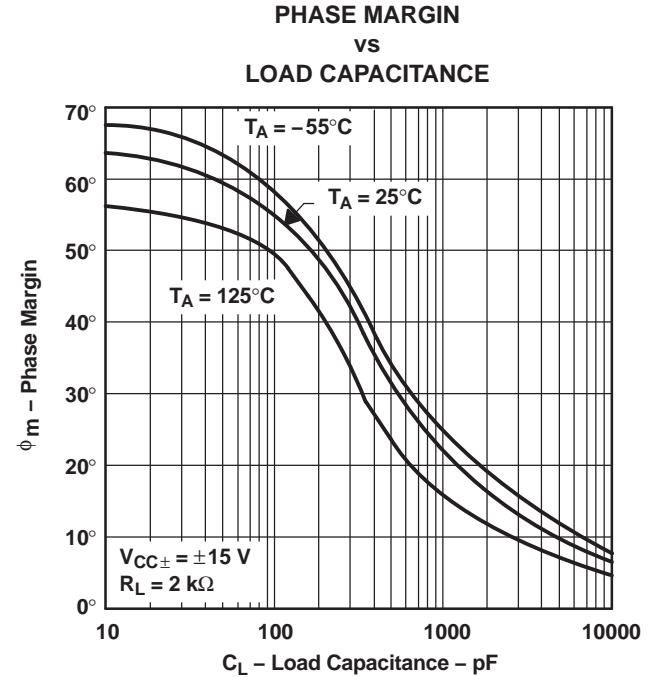

Figure 36.

APPLICATION INFORMATION

Input Offset Voltage Nulling

The TLE2141 offers external null pins that can be used to further reduce the input offset voltage. If this feature is desired, connect the circuit of [Figure 37](#) as shown. If external nulling is not needed, the null pins may be left unconnected.

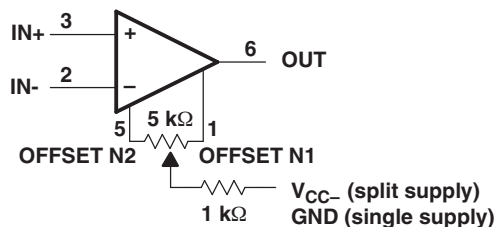

Figure 37. Input Offset Voltage Null Circuit

TAPE AND REEL INFORMATION



QUADRANT ASSIGNMENTS FOR PIN 1 ORIENTATION IN TAPE



*All dimensions are nominal

Device	Package Type	Package Drawing	Pins	SPQ	Reel Diameter (mm)	Reel Width W1 (mm)	A0 (mm)	B0 (mm)	K0 (mm)	P1 (mm)	W (mm)	Pin1 Quadrant
TLE2141MDREP	SOIC	D	8	2500	330.0	12.4	6.4	5.2	2.1	8.0	12.0	Q1

TAPE AND REEL BOX DIMENSIONS



*All dimensions are nominal

Device	Package Type	Package Drawing	Pins	SPQ	Length (mm)	Width (mm)	Height (mm)
TLE2141MDREP	SOIC	D	8	2500	340.5	338.1	20.6

D (R-PDSO-G8)

PLASTIC SMALL-OUTLINE PACKAGE

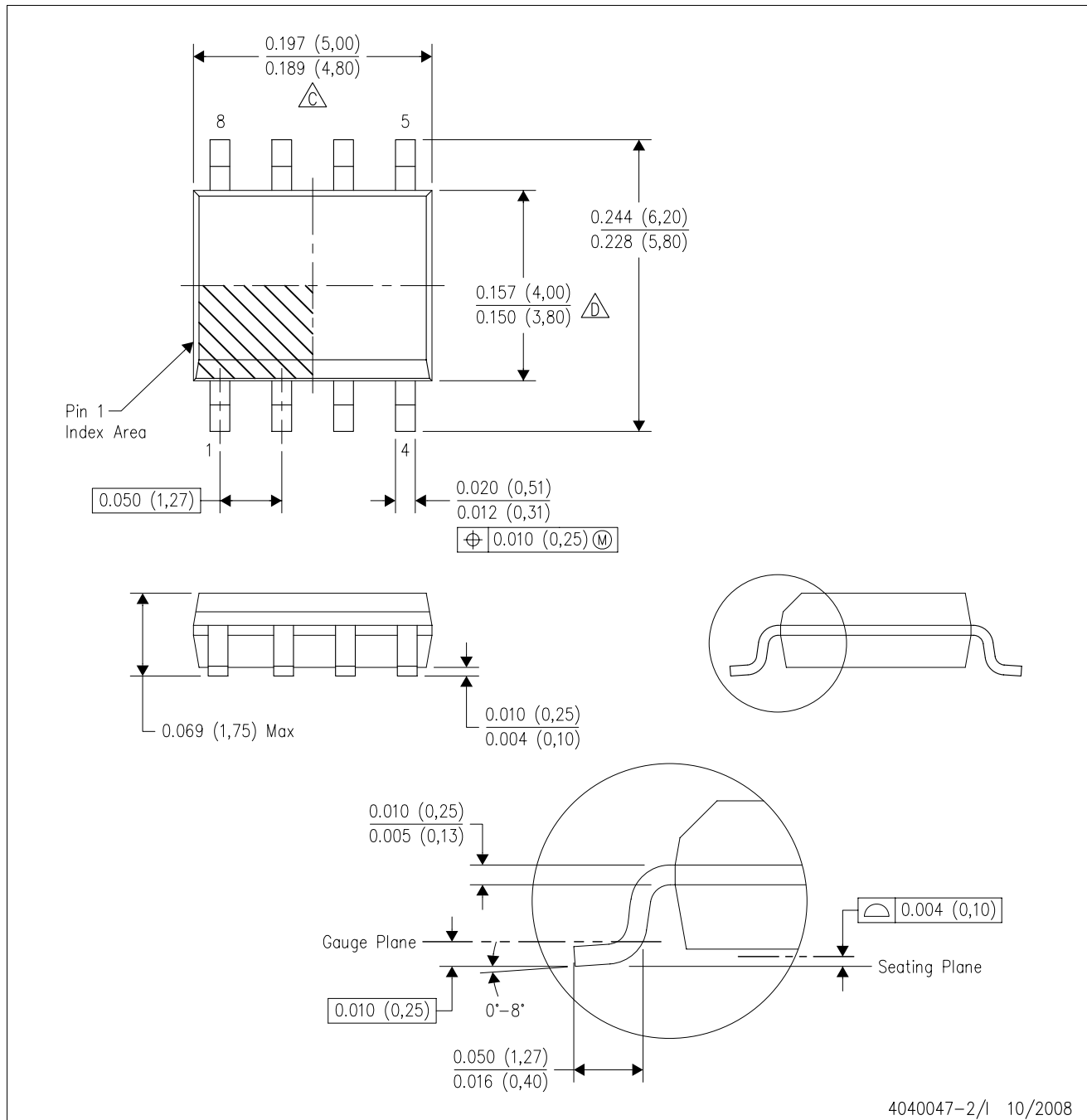

- NOTES:
- A. All linear dimensions are in inches (millimeters).
 - B. This drawing is subject to change without notice.
 - C. Body length does not include mold flash, protrusions, or gate burrs. Mold flash, protrusions, or gate burrs shall not exceed .006 (0,15) per end.
 - D. Body width does not include interlead flash. Interlead flash shall not exceed .017 (0,43) per side.
 - E. Reference JEDEC MS-012 variation AA.

DW (R-PDSO-G16)

PLASTIC SMALL-OUTLINE PACKAGE

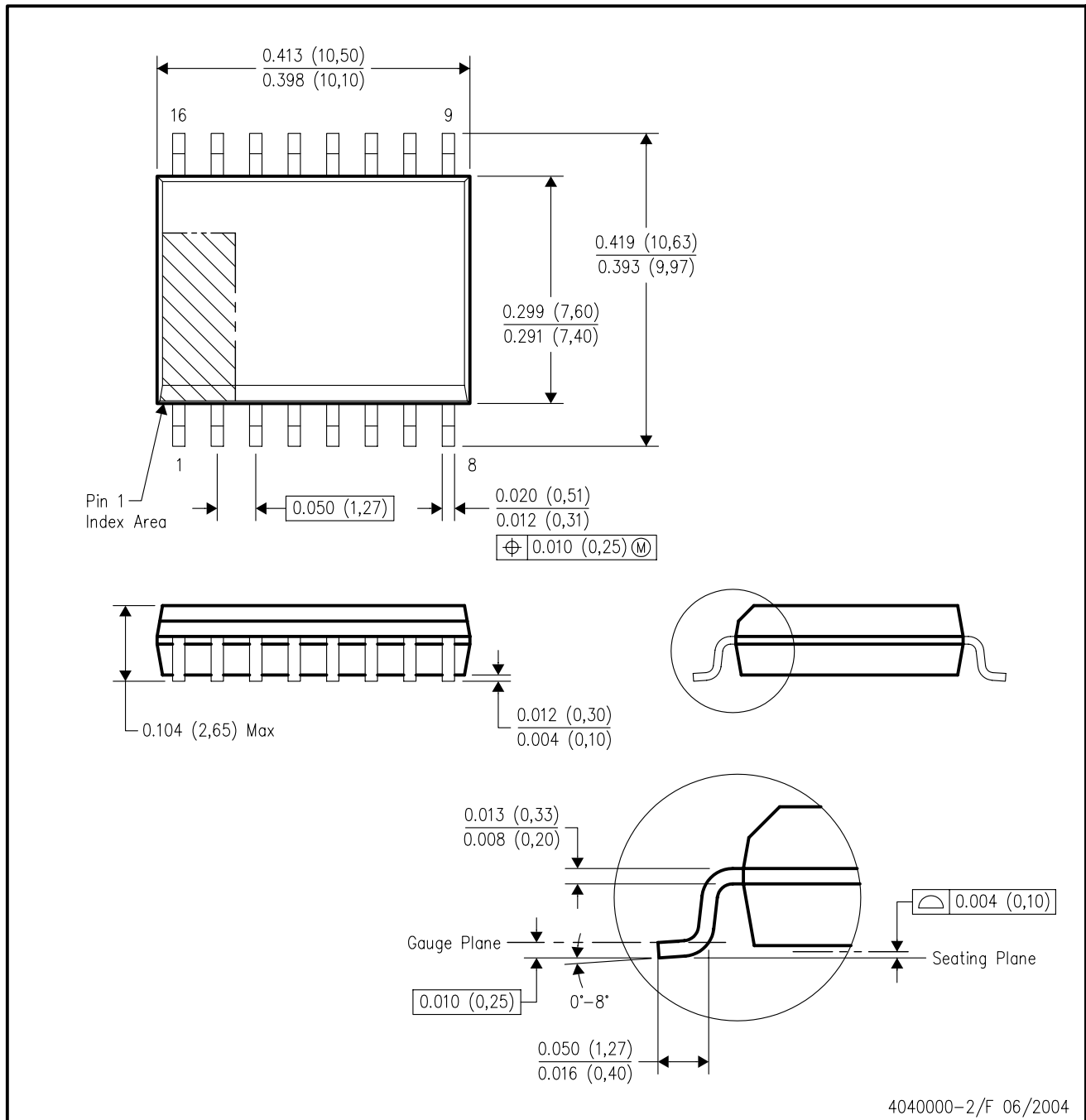

4040000-2/F 06/2004

- NOTES:
- A. All linear dimensions are in inches (millimeters).
 - B. This drawing is subject to change without notice.
 - C. Body dimensions do not include mold flash or protrusion not to exceed 0.006 (0,15).
 - D. Falls within JEDEC MS-013 variation AA.

IMPORTANT NOTICE

Texas Instruments Incorporated and its subsidiaries (TI) reserve the right to make corrections, modifications, enhancements, improvements, and other changes to its products and services at any time and to discontinue any product or service without notice. Customers should obtain the latest relevant information before placing orders and should verify that such information is current and complete. All products are sold subject to TI's terms and conditions of sale supplied at the time of order acknowledgment.

TI warrants performance of its hardware products to the specifications applicable at the time of sale in accordance with TI's standard warranty. Testing and other quality control techniques are used to the extent TI deems necessary to support this warranty. Except where mandated by government requirements, testing of all parameters of each product is not necessarily performed.

TI assumes no liability for applications assistance or customer product design. Customers are responsible for their products and applications using TI components. To minimize the risks associated with customer products and applications, customers should provide adequate design and operating safeguards.

TI does not warrant or represent that any license, either express or implied, is granted under any TI patent right, copyright, mask work right, or other TI intellectual property right relating to any combination, machine, or process in which TI products or services are used. Information published by TI regarding third-party products or services does not constitute a license from TI to use such products or services or a warranty or endorsement thereof. Use of such information may require a license from a third party under the patents or other intellectual property of the third party, or a license from TI under the patents or other intellectual property of TI.

Reproduction of TI information in TI data books or data sheets is permissible only if reproduction is without alteration and is accompanied by all associated warranties, conditions, limitations, and notices. Reproduction of this information with alteration is an unfair and deceptive business practice. TI is not responsible or liable for such altered documentation. Information of third parties may be subject to additional restrictions.

Resale of TI products or services with statements different from or beyond the parameters stated by TI for that product or service voids all express and any implied warranties for the associated TI product or service and is an unfair and deceptive business practice. TI is not responsible or liable for any such statements.

TI products are not authorized for use in safety-critical applications (such as life support) where a failure of the TI product would reasonably be expected to cause severe personal injury or death, unless officers of the parties have executed an agreement specifically governing such use. Buyers represent that they have all necessary expertise in the safety and regulatory ramifications of their applications, and acknowledge and agree that they are solely responsible for all legal, regulatory and safety-related requirements concerning their products and any use of TI products in such safety-critical applications, notwithstanding any applications-related information or support that may be provided by TI. Further, Buyers must fully indemnify TI and its representatives against any damages arising out of the use of TI products in such safety-critical applications.

TI products are neither designed nor intended for use in military/aerospace applications or environments unless the TI products are specifically designated by TI as military-grade or "enhanced plastic." Only products designated by TI as military-grade meet military specifications. Buyers acknowledge and agree that any such use of TI products which TI has not designated as military-grade is solely at the Buyer's risk, and that they are solely responsible for compliance with all legal and regulatory requirements in connection with such use.

TI products are neither designed nor intended for use in automotive applications or environments unless the specific TI products are designated by TI as compliant with ISO/TS 16949 requirements. Buyers acknowledge and agree that, if they use any non-designated products in automotive applications, TI will not be responsible for any failure to meet such requirements.

Following are URLs where you can obtain information on other Texas Instruments products and application solutions:

Products

Amplifiers	amplifier.ti.com
Data Converters	dataconverter.ti.com
DSP	dsp.ti.com
Clocks and Timers	www.ti.com/clocks
Interface	interface.ti.com
Logic	logic.ti.com
Power Mgmt	power.ti.com
Microcontrollers	microcontroller.ti.com
RFID	www.ti-rfid.com
RF/IF and ZigBee® Solutions	www.ti.com/lprf

Applications

Audio	www.ti.com/audio
Automotive	www.ti.com/automotive
Broadband	www.ti.com/broadband
Digital Control	www.ti.com/digitalcontrol
Medical	www.ti.com/medical
Military	www.ti.com/military
Optical Networking	www.ti.com/opticalnetwork
Security	www.ti.com/security
Telephony	www.ti.com/telephony
Video & Imaging	www.ti.com/video
Wireless	www.ti.com/wireless

Mailing Address: Texas Instruments, Post Office Box 655303, Dallas, Texas 75265
Copyright © 2008, Texas Instruments Incorporated